

401*

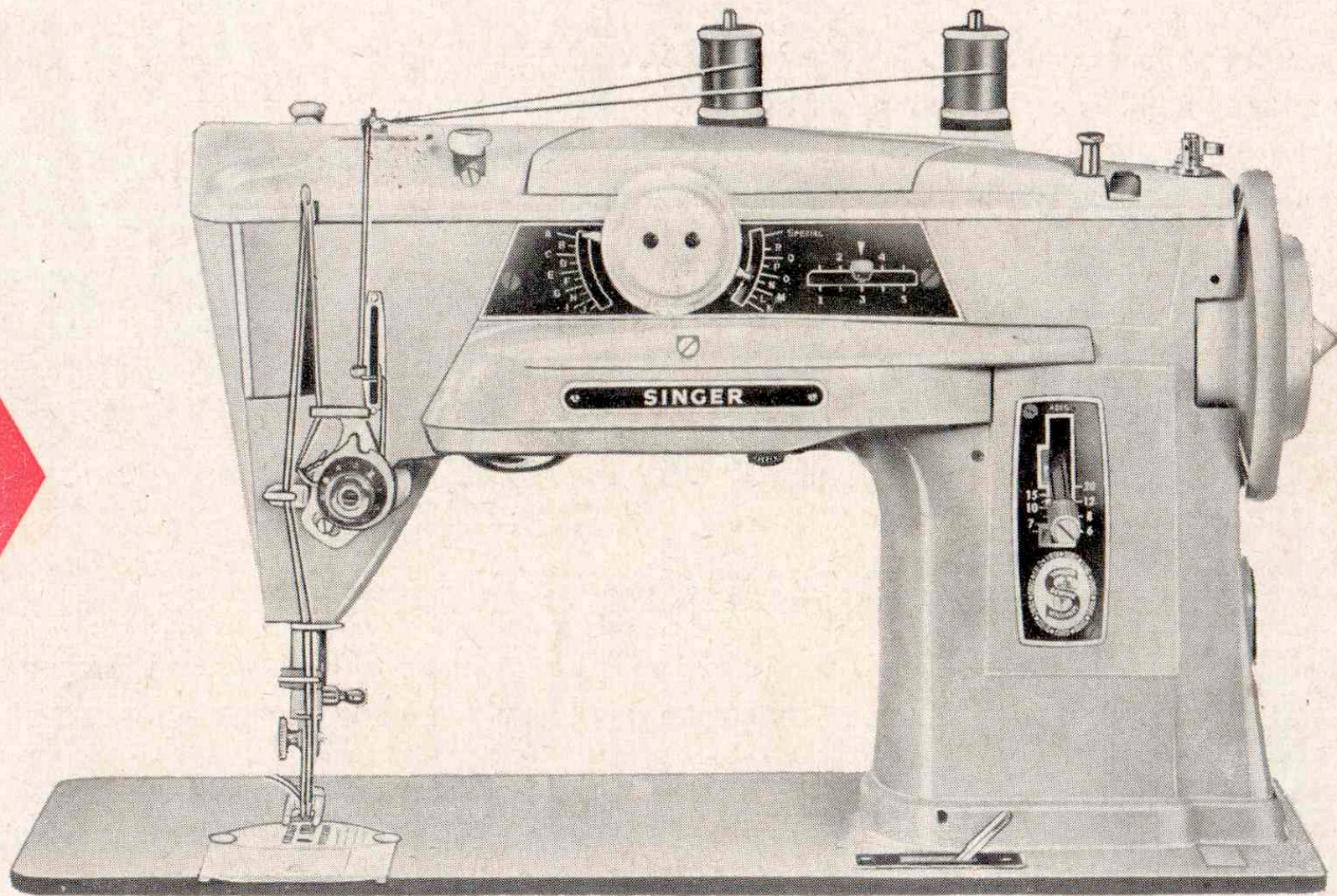

The **SLANT-O-MATIC** – the greatest sewing machine ever built!

*A Trademark of THE SINGER MANUFACTURING COMPANY

Form 4101/360

The SINGER SLANT-O-MATIC the greatest sewing machine ever built . . .

From the moment you see the new SLANT-O-MATIC, you'll know it's excitingly different. You'll marvel at its automatic sewing . . . its almost unbelievable ease of operation . . . the remarkable services it performs. You'll delight in its sure, beautiful stitching.

- World's first automatic with a slant needle and gear drive. Sewing is easier, sewing smoothest ever. No slipping or stalling.

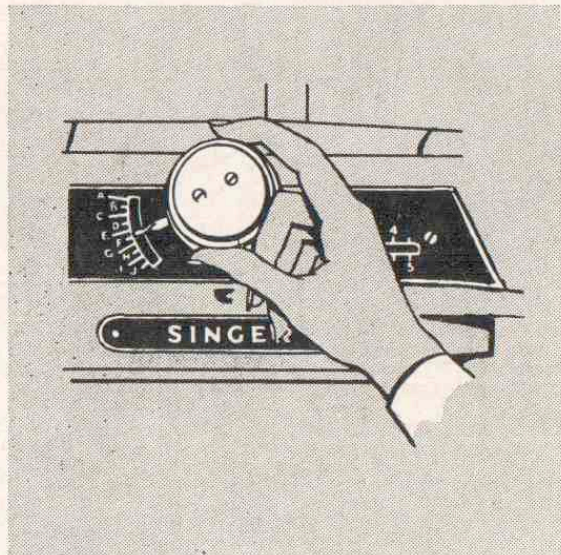

- World's first automatic with double easy threading. Has built-in threading chart, handy "drop-in" bobbin in front of needle!
 - World's first automatic with a built-in eye-level stitch chart, that lets you "tune" the knob for whatever fancy stitch you want!
- Add to these major developments in sewing machine design the following ADVANCED features, and you have a machine far ahead in design, unequalled in performance.

- **ELEVATOR TYPE** multi-purpose calibrated throat plate, lever operated, simplifies darning.
- **HINGED** face plate swings open for easy cleaning.
- **SUPERFINE CONTROL** of stitch length ensures perfect satin stitching.
- **PERFECT** Straight Stitching.
- **BUILT-IN LIGHT** focused on sewing area.
- **NEW NEEDLE CLAMP** holds one or two regular needles—same or different sizes for exciting twin needle stitching.
- **ALL MECHANISM** completely enclosed.
- **NEW AUTOMATIC THREAD CONTROL.**
- **NEW SPECIAL PURPOSE FOOT.**
- **NEW SEAM GUIDE.**

**TO GET THE MOST ENJOYMENT
FROM YOUR SINGER**

Take advantage of the free sewing lessons to which you are entitled! Skilled, SINGER-trained teachers will give you personal guidance and assist you in learning the fundamentals of home sewing.



SINGER SERVICE

Wherever you go you will find expert, dependable SINGER* Service close at hand. SINGER is interested in helping you keep your SINGER Sewing Machine in top running condition. That is why you should always call your SINGER SEWING CENTRE if your machine ever requires adjustment or repair. Only from your SINGER SEWING CENTRE can you obtain the services of a trained SINGER repair man and warranted SINGER* parts.



EVERYTHING FOR THE WOMAN WHO SEWS

The answer to your sewing needs is at your SINGER SEWING CENTRE. There you will find a wide choice of sewing aids, notions, sewing instructions and services. Look for the famous red "S" and SINGER trademarks on your SINGER SEWING CENTRE and the ever ready SINGER Service Car. See phone book under SINGER SEWING MACHINE CO. for address nearest you.

NEEDLE AND THREAD SELECTION

The selection of thread should be based on the fabric to be stitched. The thread should blend with the fabric in colour, fibre and size.

Silk and wool fabrics should be stitched with silk thread; cotton fabrics should be stitched with cotton or cotton mercerised thread, etc. The thread must be of a size that will imbed itself into the texture of the fabric. Thread that is too heavy for the fabric will remain on the surface and become weakened by friction and abrasion.

The selection of the needle should be based on both the fabric and thread being used. The eye of the needle must be large enough for the thread to pass freely through it. The blade of the needle must be fine enough not to mar the fabric with too large a puncture, yet heavy enough to pierce the fabric without binding or deflecting.

You will obtain best stitching results from your Sewing Machine if it is fitted with a SINGER* Needle.

NEEDLES AND THREAD

This machine uses a 15 x 1 needle.
Sizes 9, 11, 14, 16 and 18.

For perfect stitching, select correct needle and thread to correspond with fabric (see **page 5**).

Be sure to use like threads for both needle and bobbin.

NEEDLE INSERTION

Raise the needle bar to highest point by turning the hand wheel toward you. Loosen the needle clamp screw. Insert needle upward into clamp as far as it will go, with the flat side of the needle to the back and the **long groove toward you**. Tighten needle clamp screw.

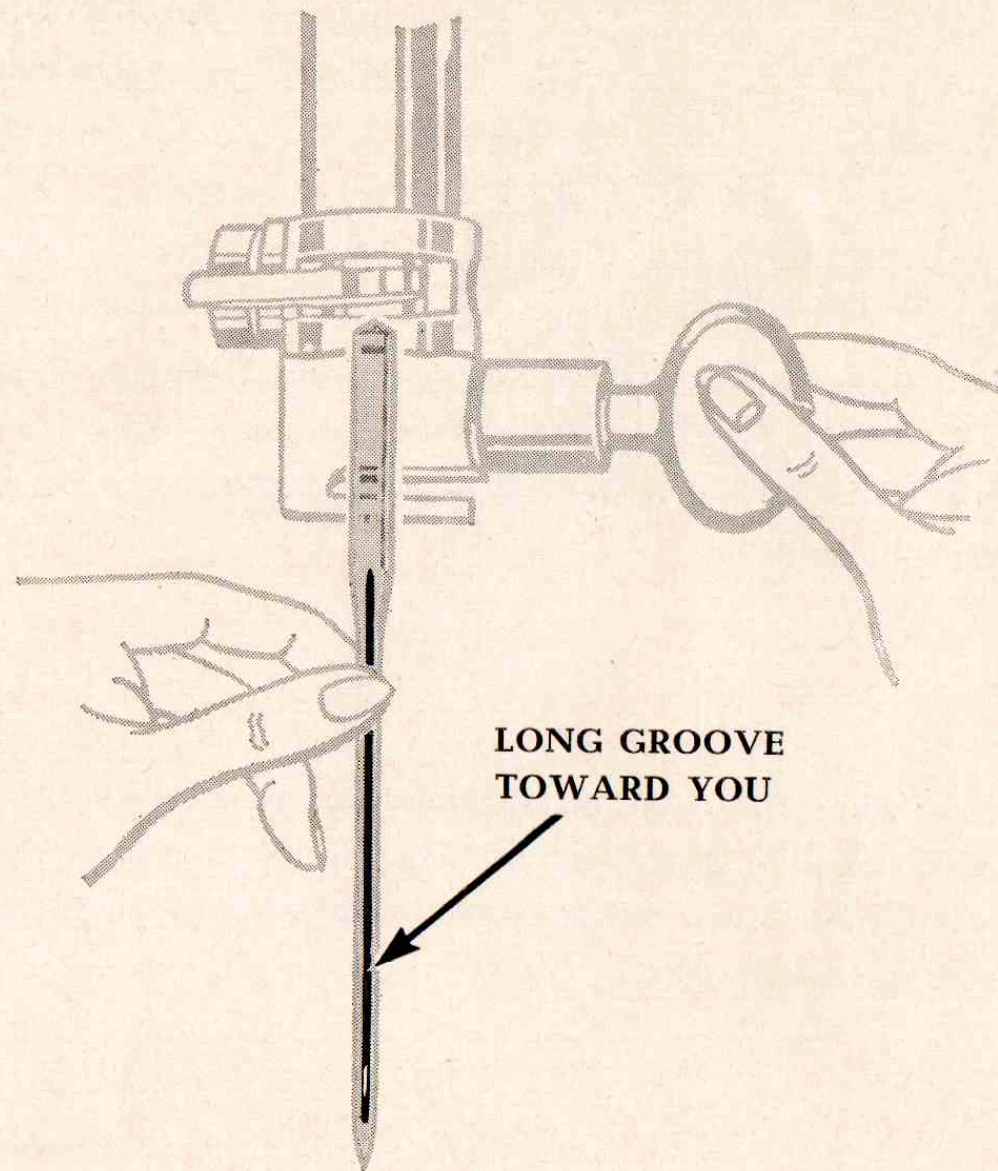

TO OPERATE MACHINE

(Electric Drive)

Place material under the presser foot and lower foot. Connect plug to electric outlet (see page 90). Start machine by pressing controller. (If installed as knee controller, press knee lever to the right; if installed as foot controller, press down on foot pedal.)

The speed of the machine depends entirely on the amount of pressure applied to the controller.

Practice operating the machine (without thread) until you become accustomed to guiding material and regulating machine speed.

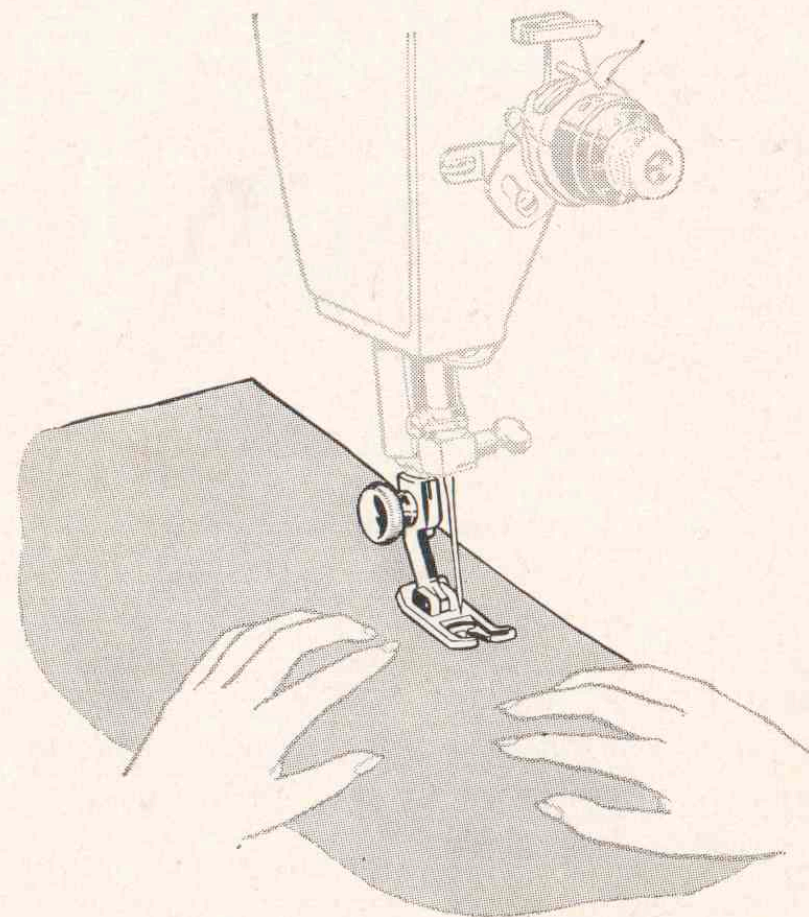

TO OPERATE THE MACHINE (Treadle Drive)

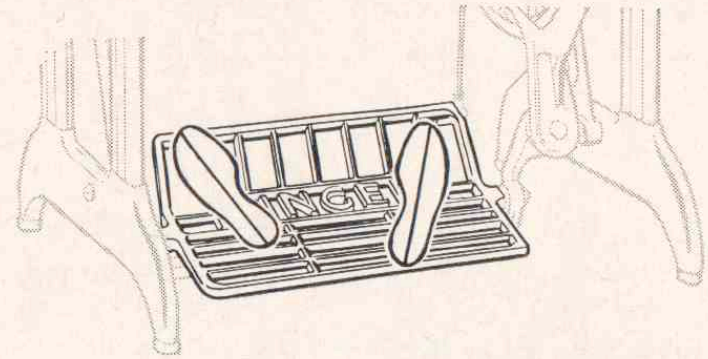
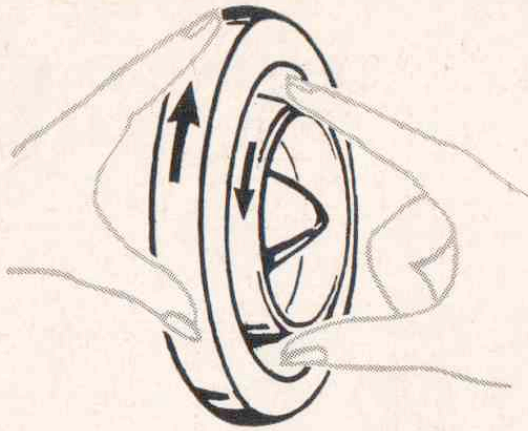

Loosen stop motion screw and place both feet on treadle.

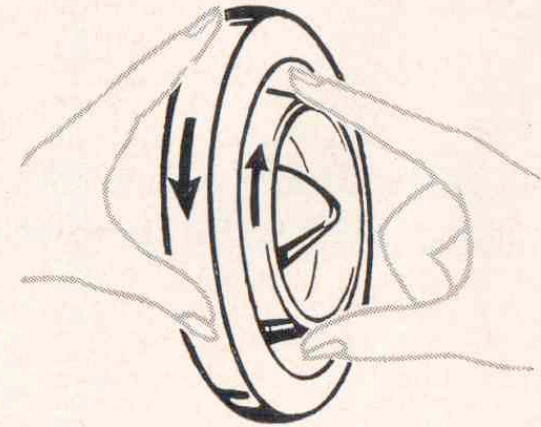
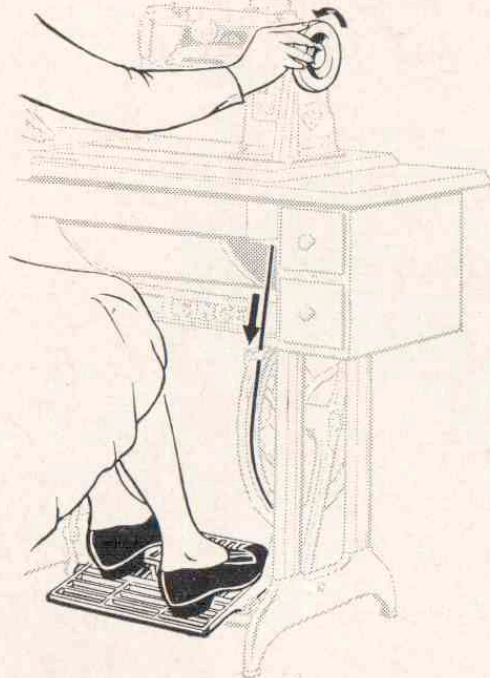

Turn hand wheel over toward you, allowing feet to move freely and lightly with motion of treadle. Practice this motion until you are able to re-start machine with hand wheel turning over toward you. Then tighten stop motion screw.

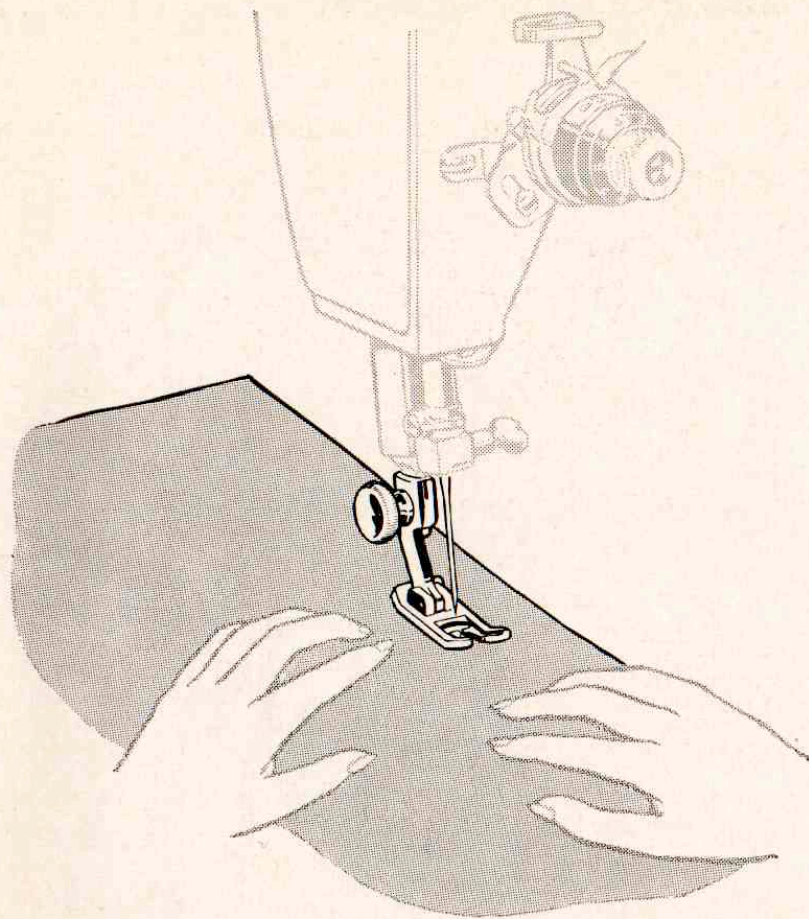

Place material under presser foot and lower the foot.

Operate machine (without thread) until you become accustomed to guiding the material.

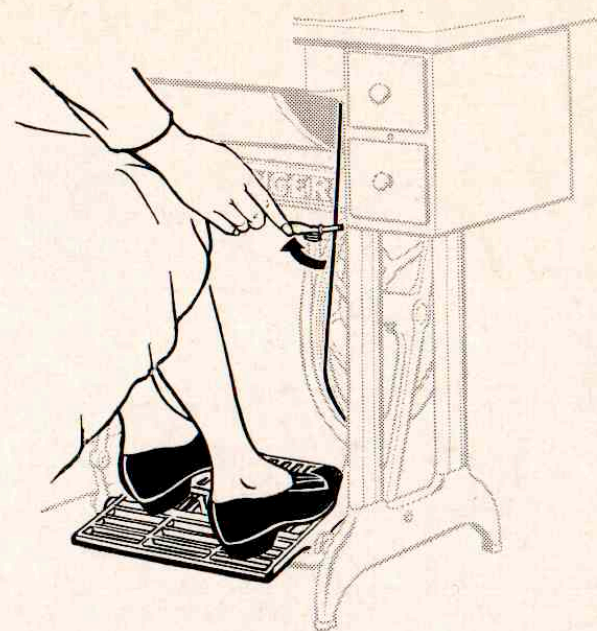

BELT SHIFTER

To throw off the belt, work the treadle and move belt shifter to position shown.

To replace belt, release belt shifter and work treadle slowly with band wheel turning over toward you. One or two revolutions of band wheel will bring belt back into place.

Note: Tension on belt should be only heavy enough to keep belt from slipping.

UPPER THREADING-SINGLE NEEDLE

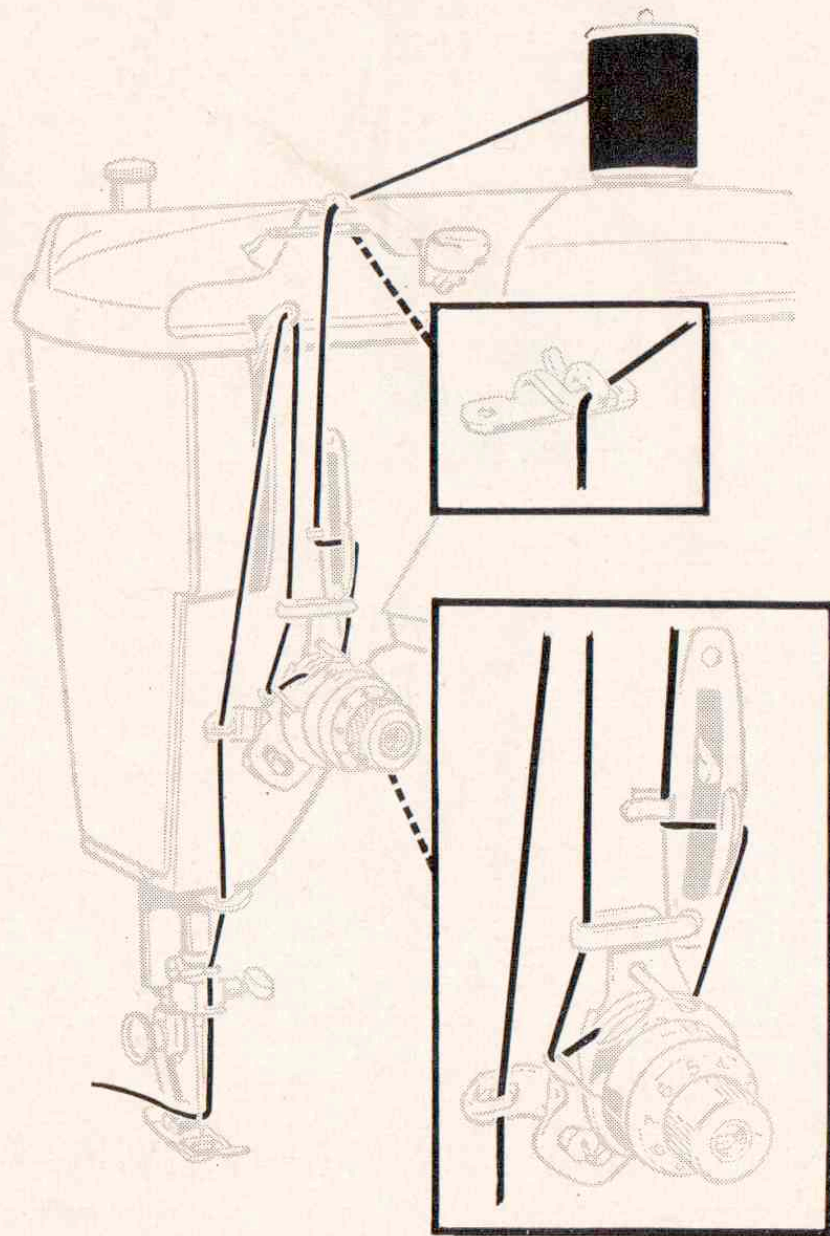

Raise take-up lever to highest point. Place thread on spool pin and lead through threading points shown. Thread needle from front to back. Draw sufficient thread through eye of needle with which to start sewing.

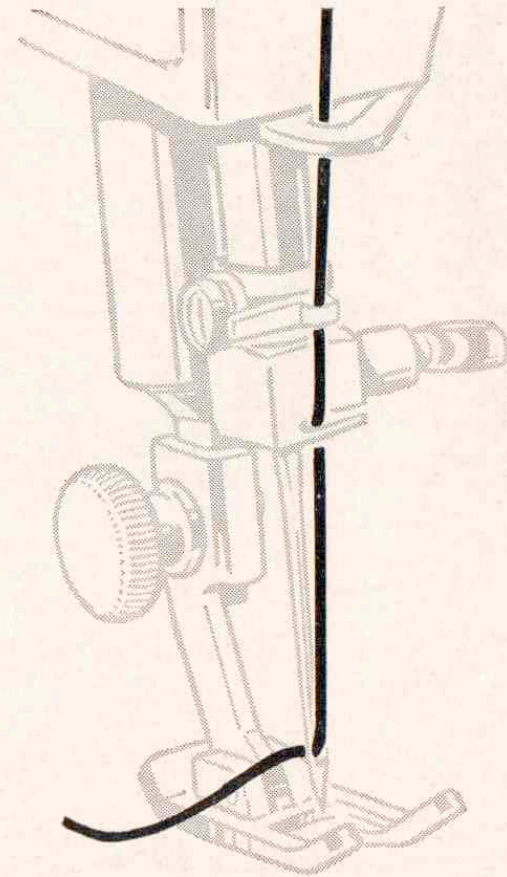

WIND THE BOBBIN

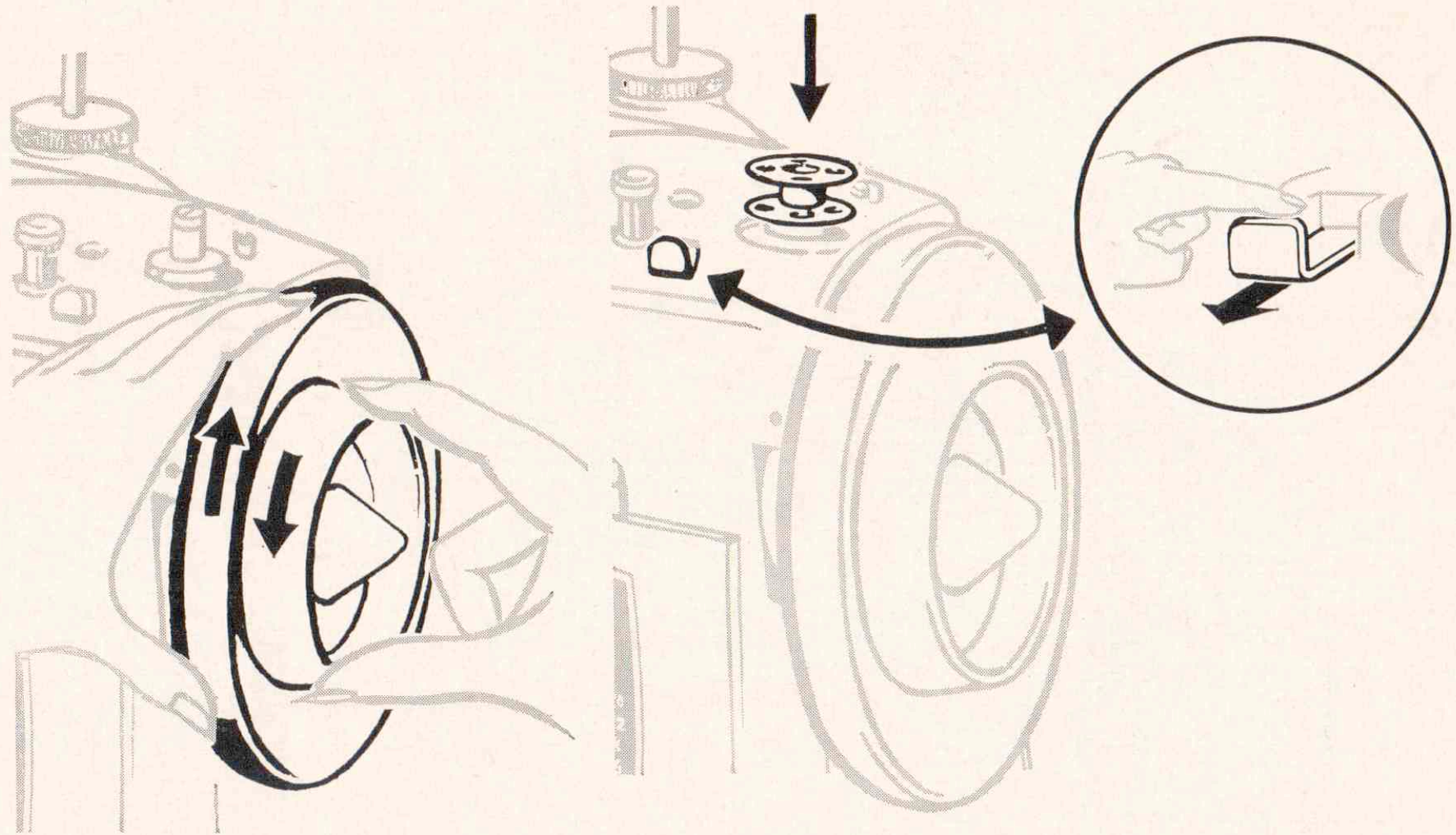

Loosen stop motion screw with right hand. Place bobbin on spindle. Pull out bobbin winder engaging slide.

WIND THE BOBBIN (Cont'd.)

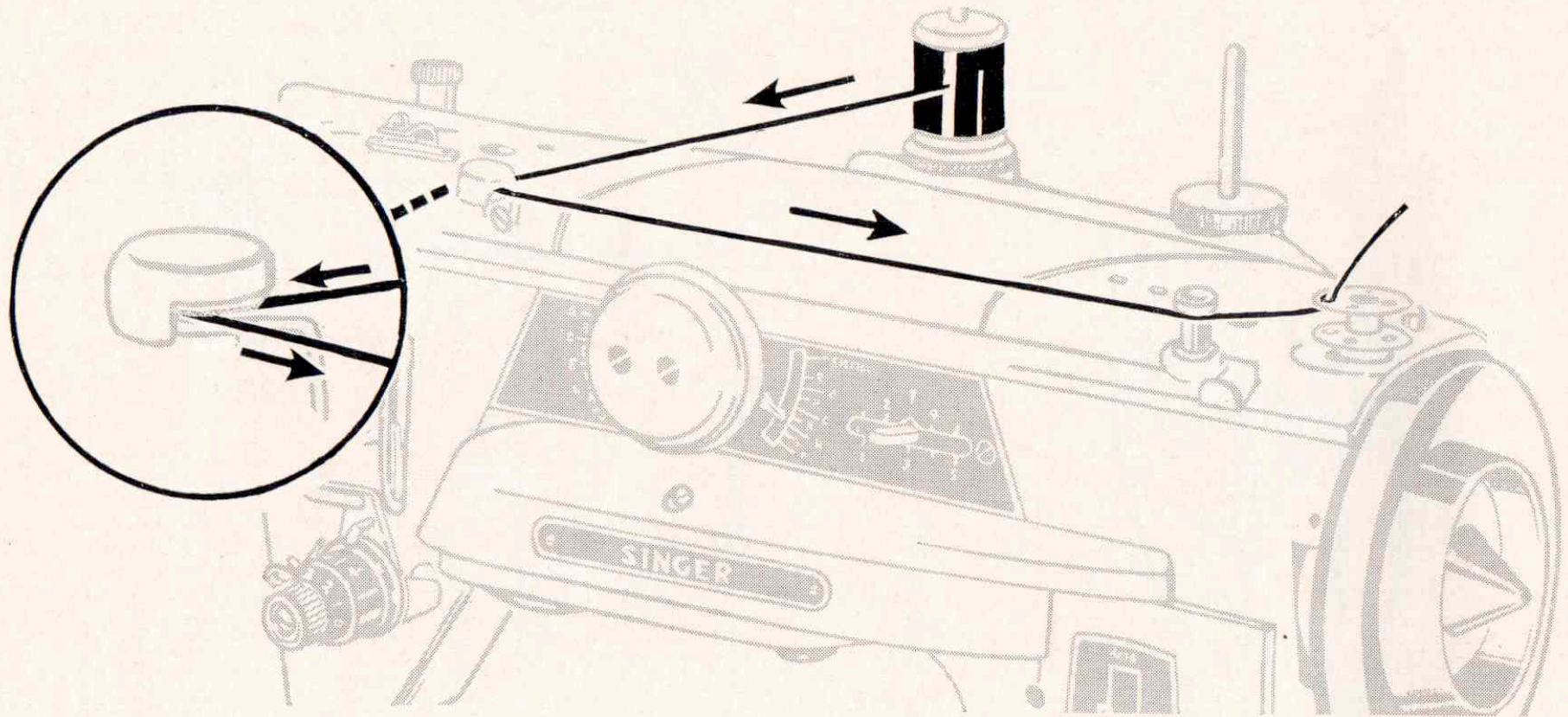

Thread the machine as shown.

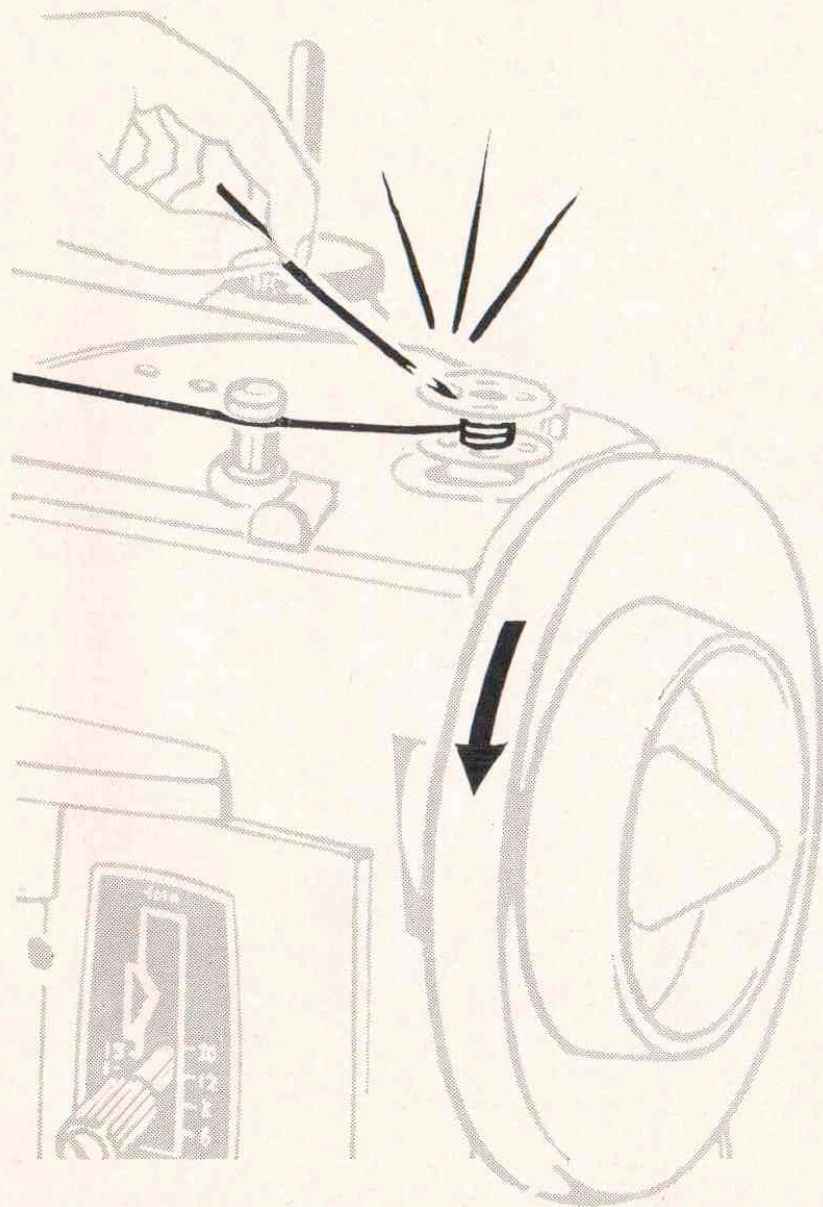

Hold end of thread and start machine.

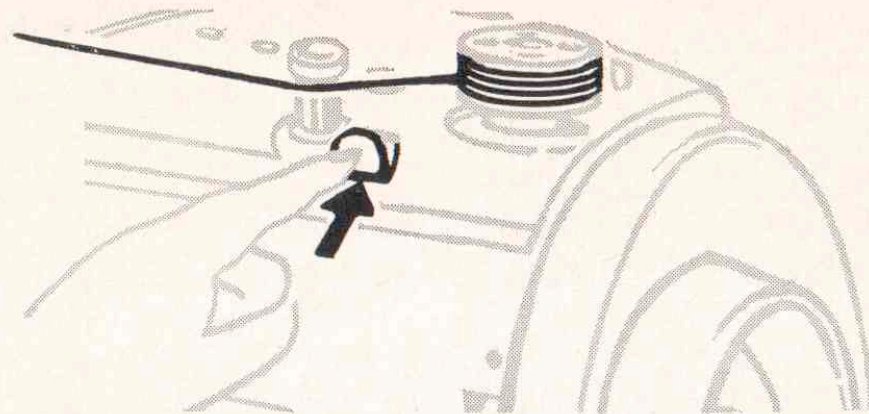

A full bobbin will automatically release. Stop machine and push in disengaging slide.

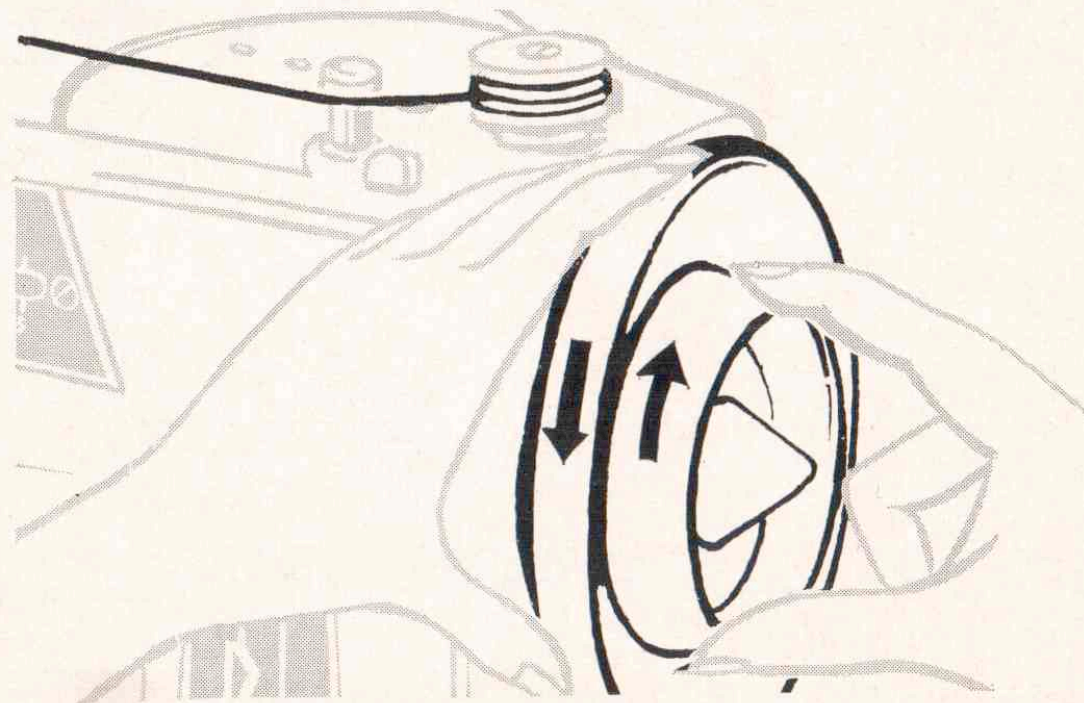

Tighten stop motion screw.

REMOVE THE BOBBIN

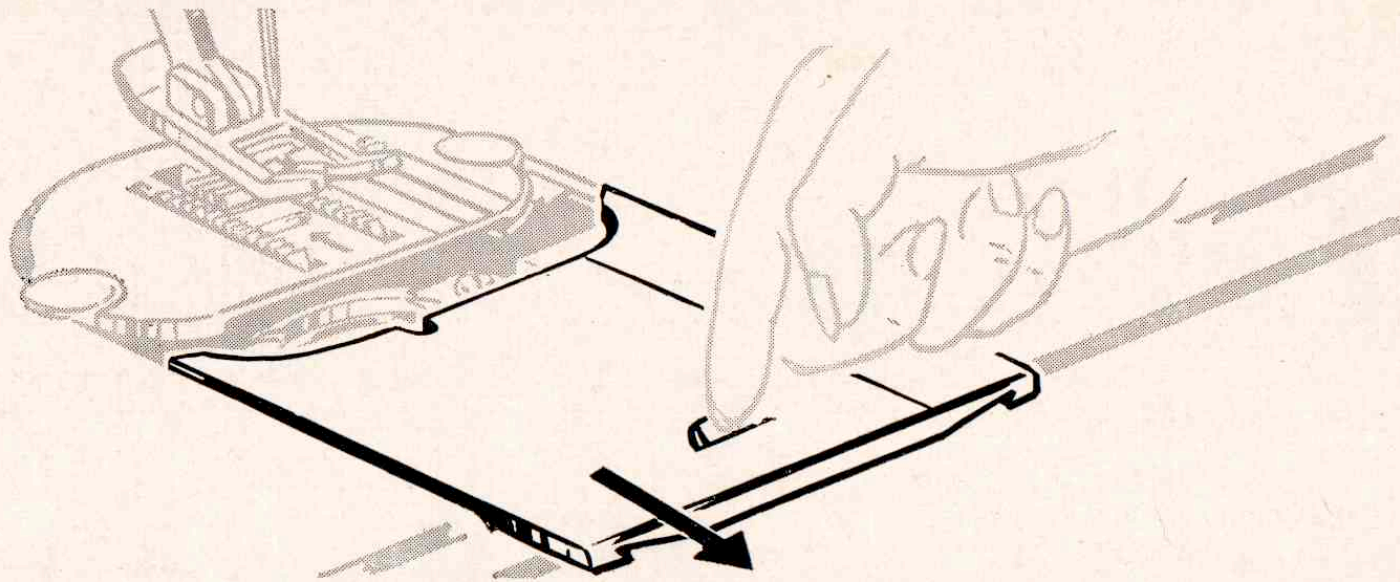

Open slide plate and remove bobbin.

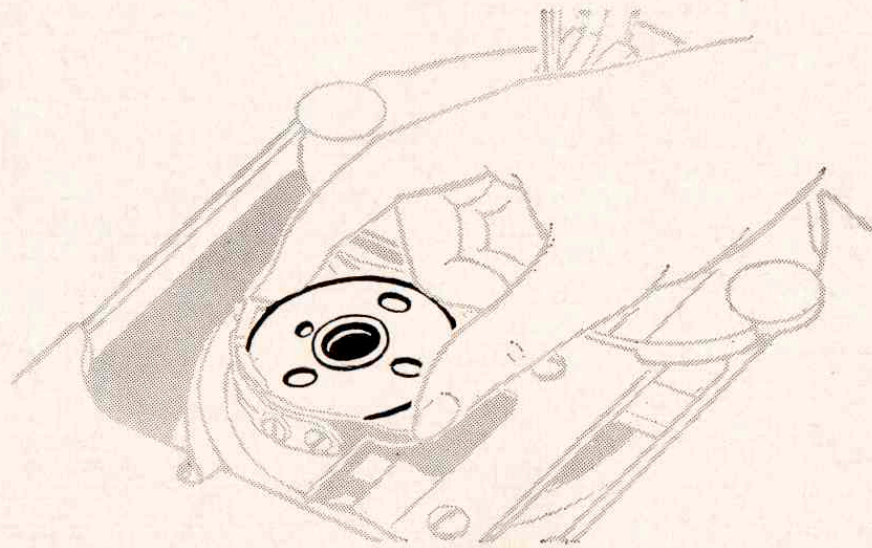

THREADING THE BOBBIN CASE

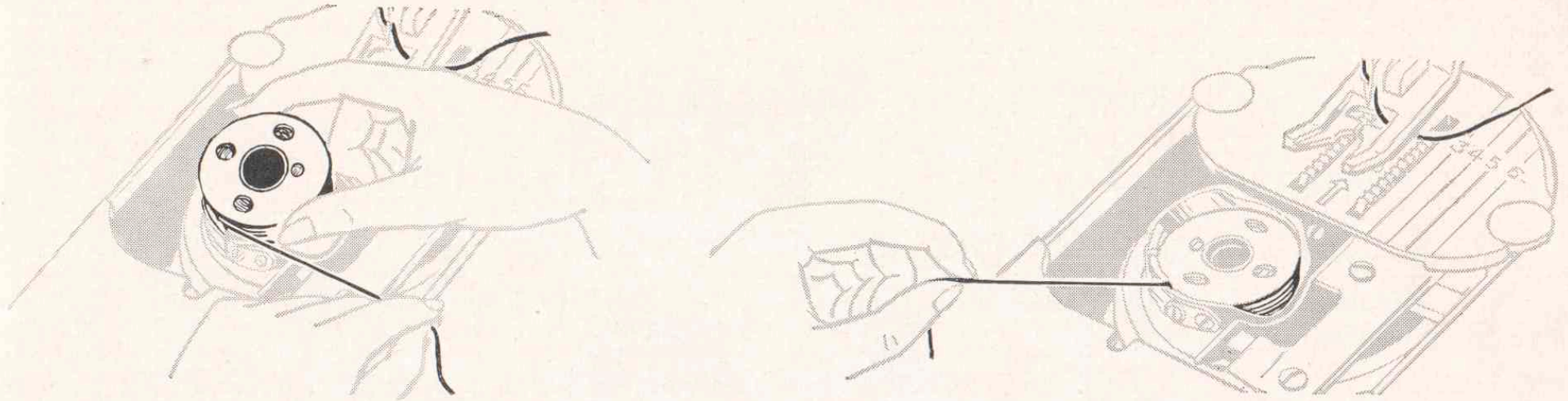

Hold bobbin so that thread leads off in direction shown. Place bobbin in case. Lead thread into slot and under spring.

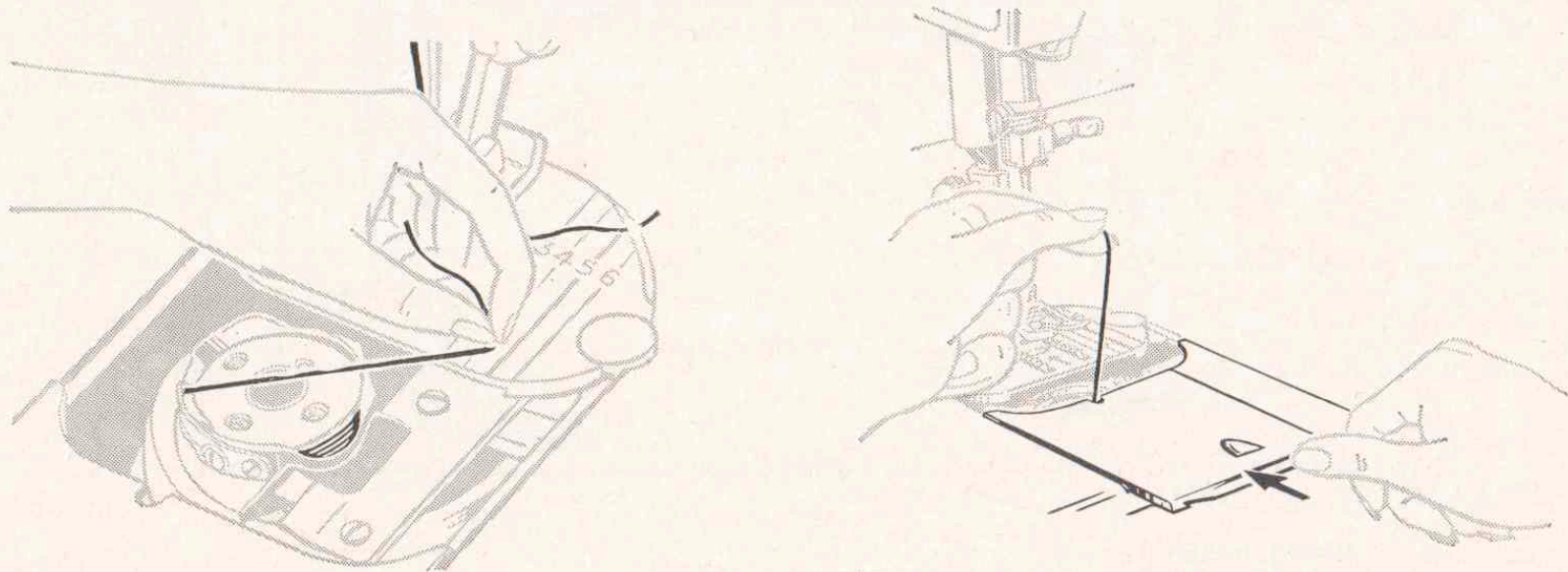

Draw thread into notch at end of spring, pulling off about 3 inches of thread across the bobbin. Close slide plate allowing thread to enter notch.

PRINCIPAL PARTS OF MACHINE 401

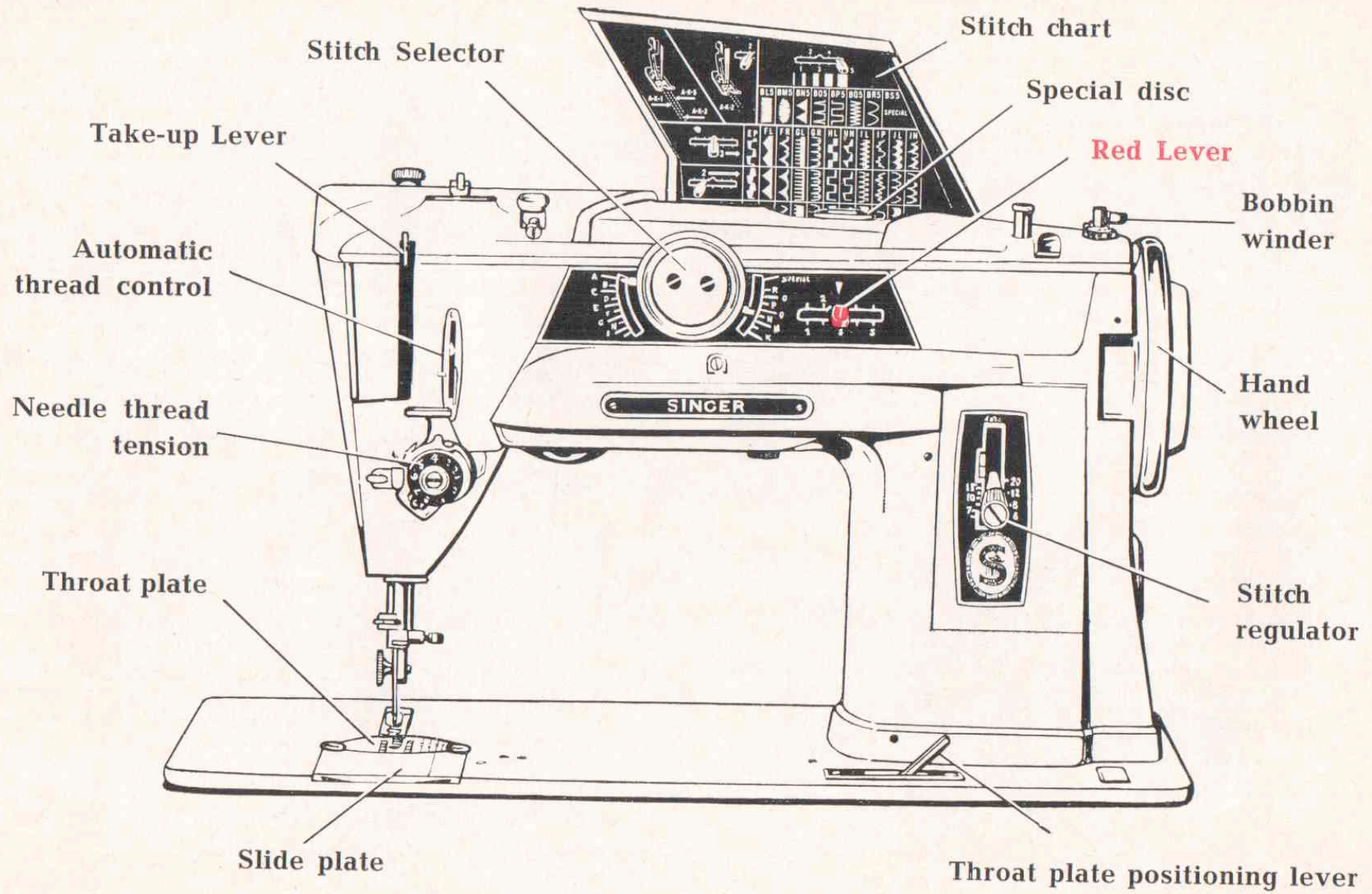

STITCH LENGTH REGULATOR

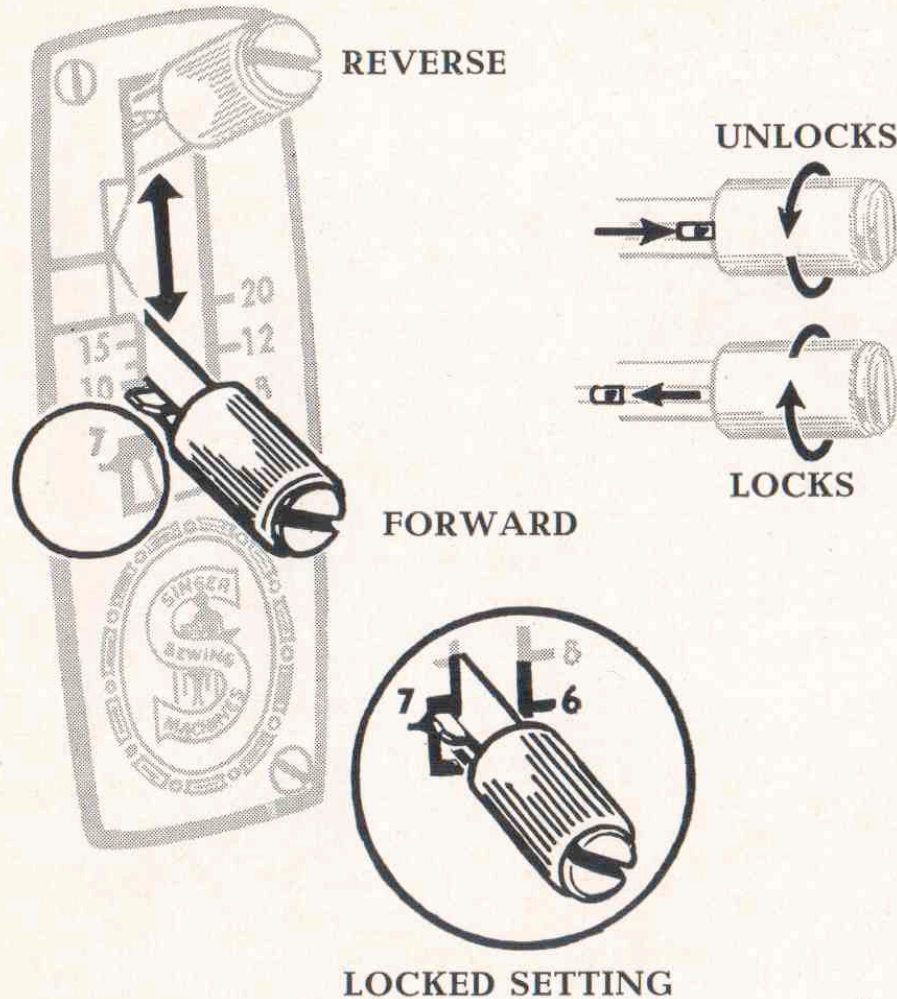

Numerals on the indicator represent the number of stitches per inch.

The upper indented area of the indicator represents stitch lengths above 20.

The lower indented area of the indicator allows the No. 6 stitch length setting to be „locked“ in place when stitching folds, pleats or multiple layers of heavy fabric.

To set stitch length: Release pointer by turning thumb nut to the left, as shown. Position lever for desired stitch length. Tighten pointer against the plate by turning thumb nut to the right.

Once the pointer has been positioned, reverse stitching is accomplished by raising the lever to its highest point. The No. 6 „locked“ position cannot be reversed.

RED LEVER

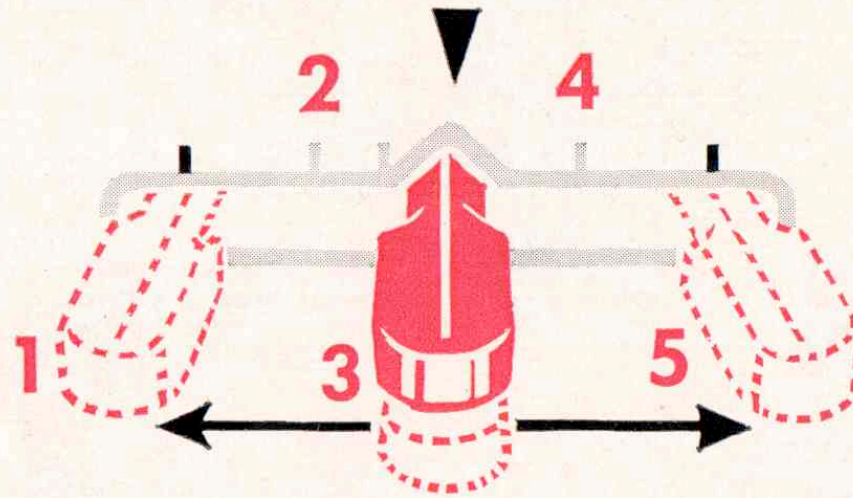

A **Red Lever** setting is necessary for both straight and zigzag stitching. Numerals indicate five positions, but intermediate settings may also be used.

To position, depress **lever** and slide it left or right to desired setting.

STITCH SELECTOR

Set Red Lever at 3.

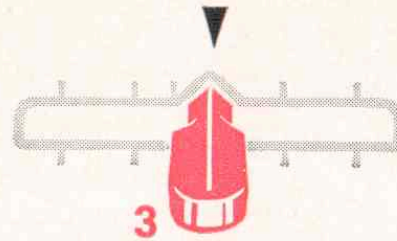

All settings on the left of the plate are controlled by the outer knob. Push (using right hand)—select desired setting and release.

All settings on the right of the plate are controlled by the inner knob. Pull (using left hand)—select desired setting and release.

Do not make selector adjustments while the needle is in the fabric.

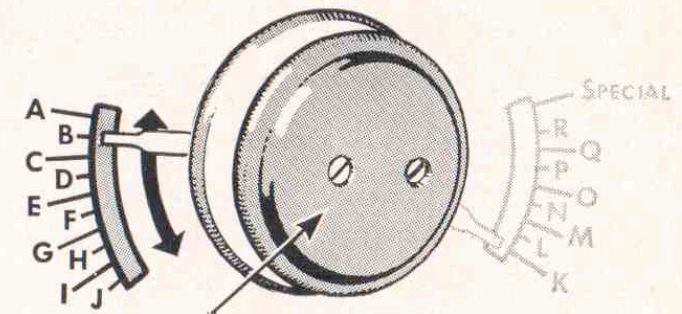
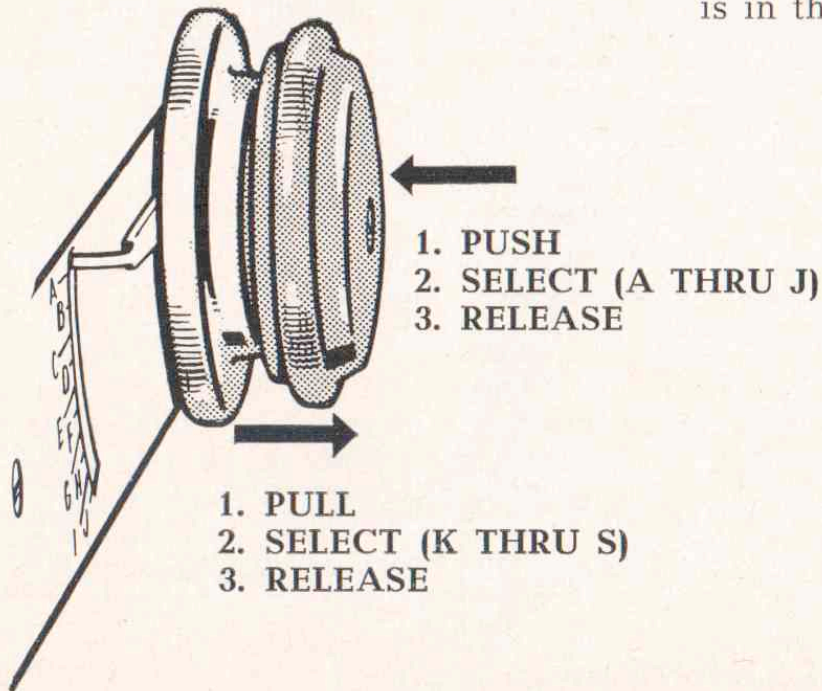

PUSH AND SELECT

PULL AND SELECT

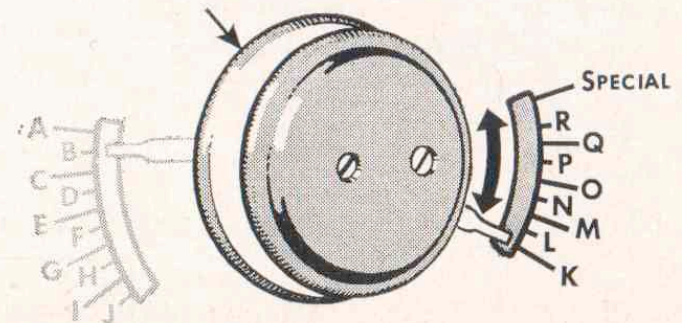

THROAT PLATE POSITIONS

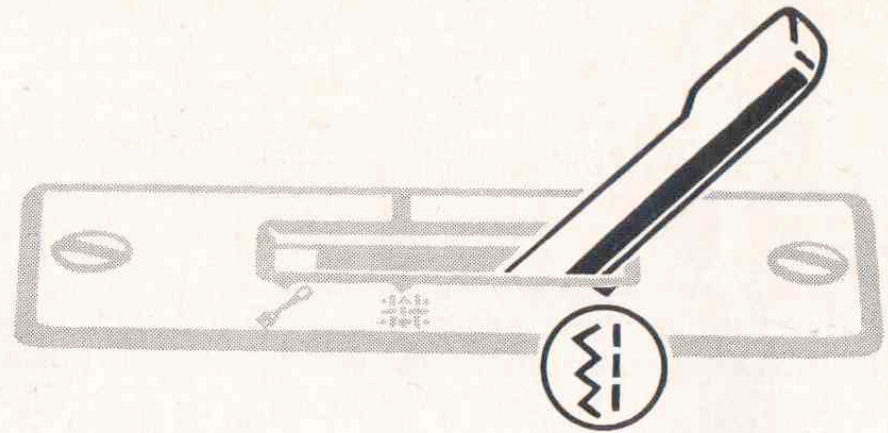
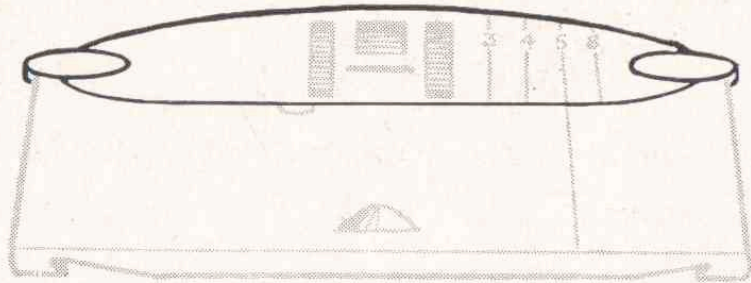

Throat plate down for general sewing.

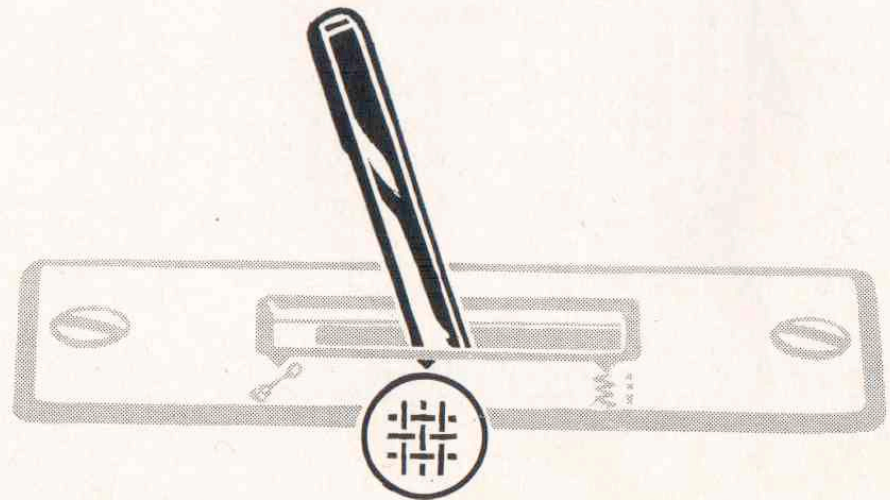
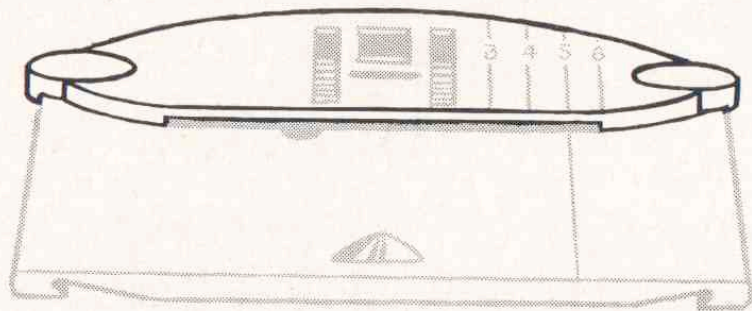

Throat plate raised for darning, embroidery and button sewing.

THROAT PLATE REMOVAL AND REPLACEMENT

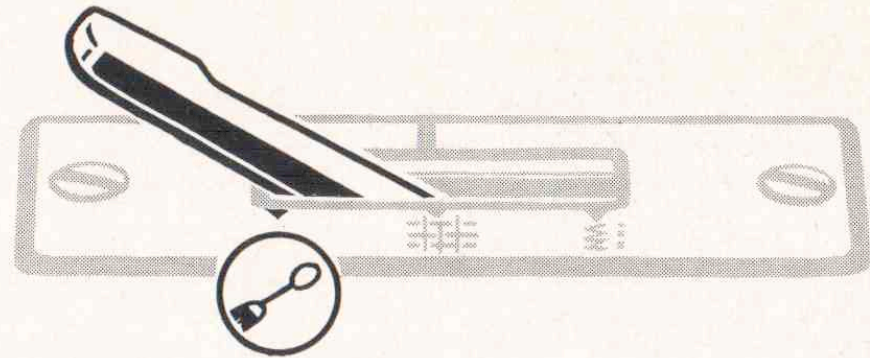
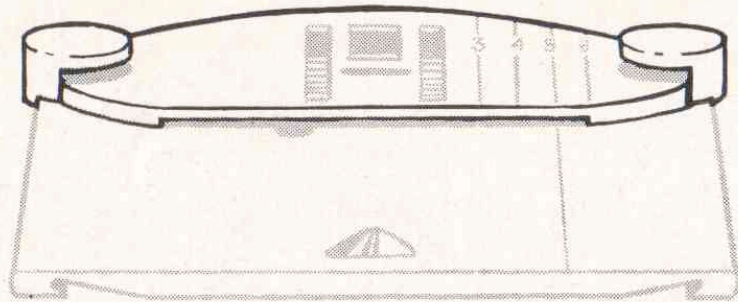

Throat plate raised (unlocked) for removal and replacement.

**TAKE-UP LEVER
MUST BE IN
LOWEST POSITION**

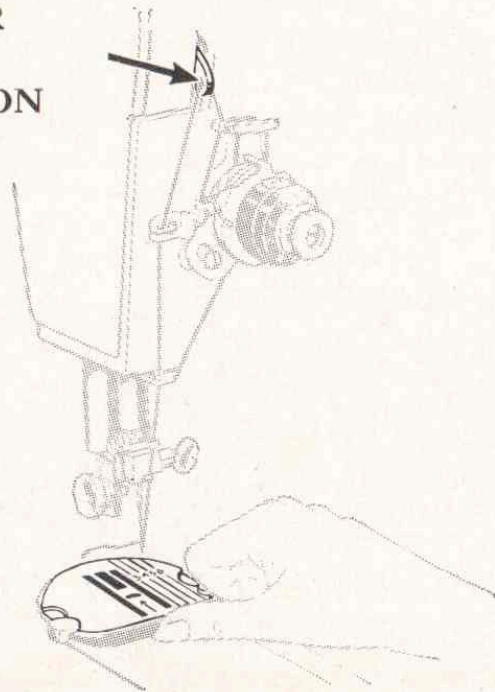

Raise presser bar. Turn hand wheel to drop take-up lever to its lowest point. Move throat plate lever to the left. This preparation applies to both removal and replacement.

Remove throat plate by sliding it back.

Replace throat plate by sliding it on from the rear.

Lock throat plate in place by moving lever to the right.

Presser foot need not be removed for this operation.

STRAIGHT STITCHING

A K 3

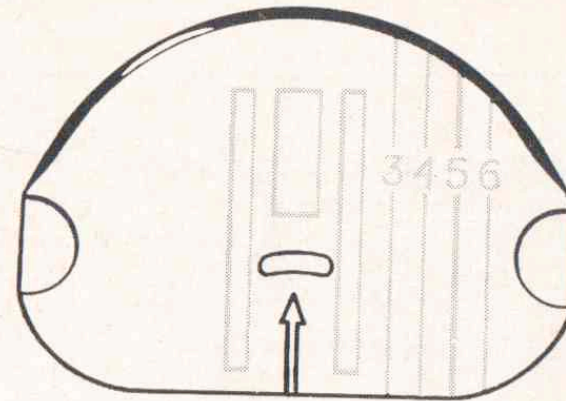
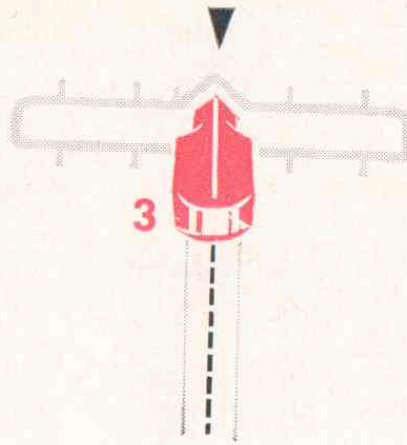
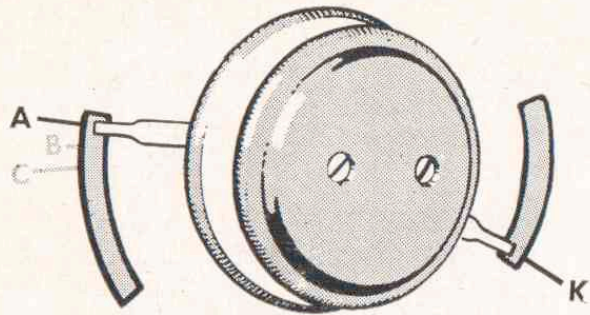

Set Selector at A K.

Red Lever at 3—TO locate stitching in central position.

General purpose throat plate and presser foot.

Use general purpose throat plate and presser foot for all utility sewing, long straight seams, etc., and where there is occasion to alternate between straight and zigzag stitching.

STRAIGHT STITCH THROAT PLATE AND PRESSER FOOT

Use the straight stitch throat plate and presser foot where fabric and sewing procedure require close control . . . for precision stitching of curved and scalloped edges, top stitching, edge stitching, etc.

For best results, this equipment should be used when stitching sheer and filmy fabrics, knits and tricots (particularly synthetics) and all soft spongy materials.

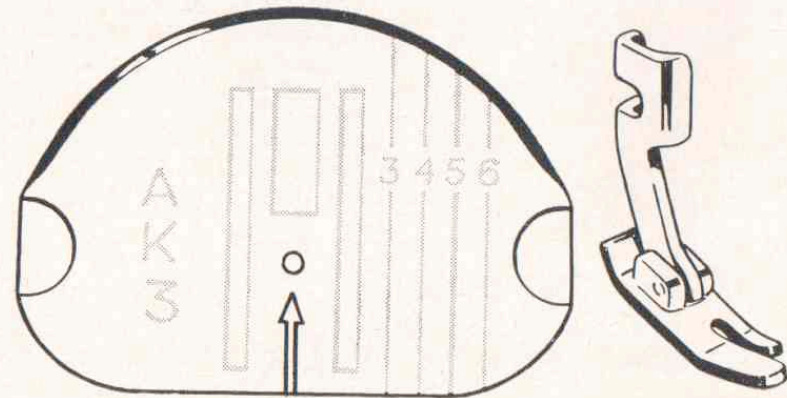

STRAIGHT STITCHING SECONDARY POSITIONS

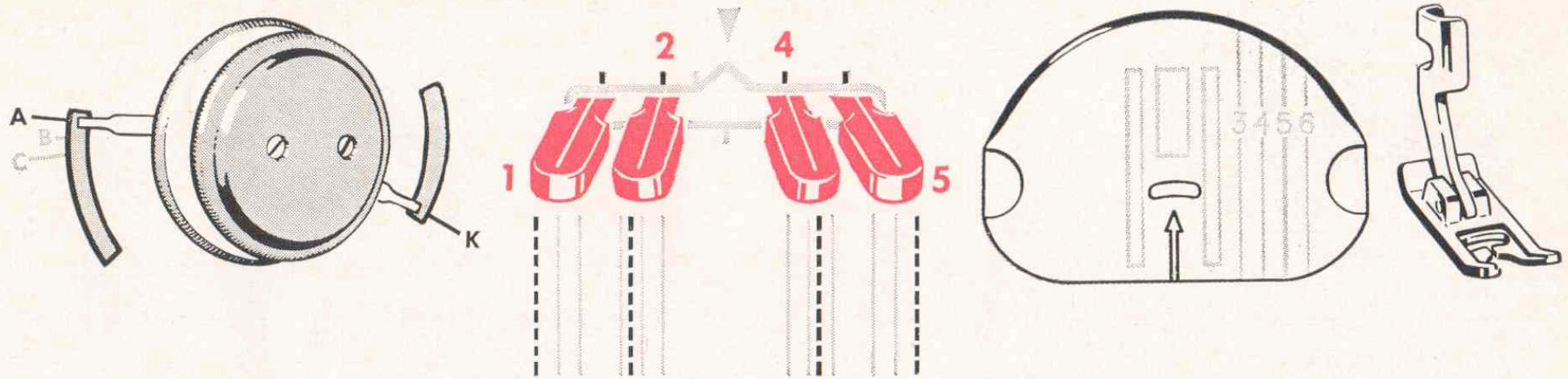

Set Selector at A K.

Red Lever at 1, 2, 4 or 5.

General purpose throat plate and presser foot.

Do not make **Red Lever** adjustments while the needle is in the fabric.

To meet special requirements a line of stitching may be placed to the right or left of centre.

Red Lever settings 1 and 2 locate stitching to the left. Settings 4 and 5 place it to the right. Intermediate settings may also be used.

PREPARE TO SEW

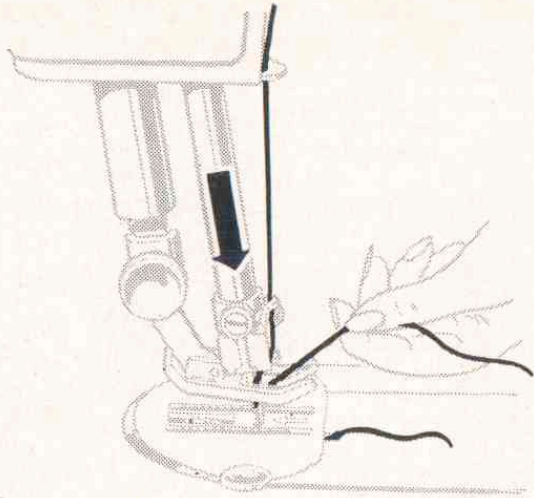

Hold needle thread lightly with left hand. Turn hand wheel so that needle enters plate and brings up bobbin thread.

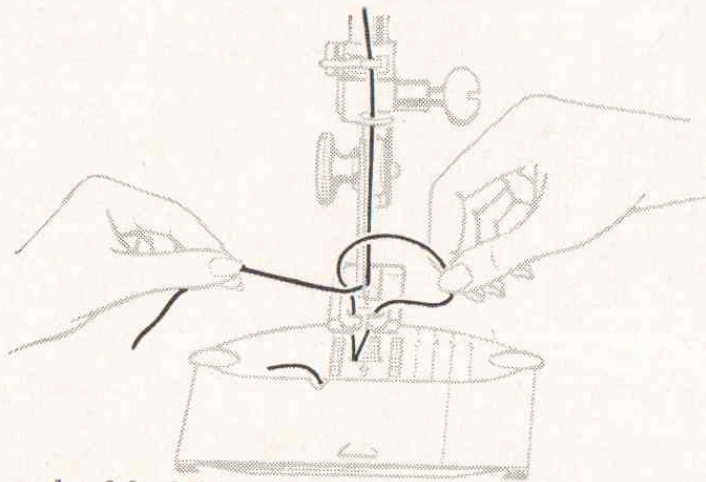
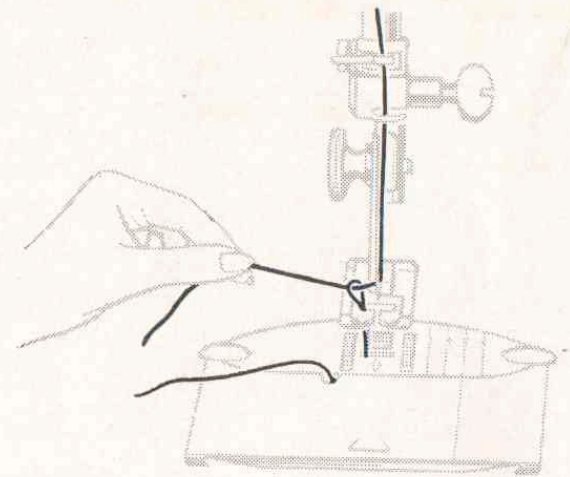

Pull end of bobbin thread through plate and place both needle and bobbin threads diagonally under presser foot.

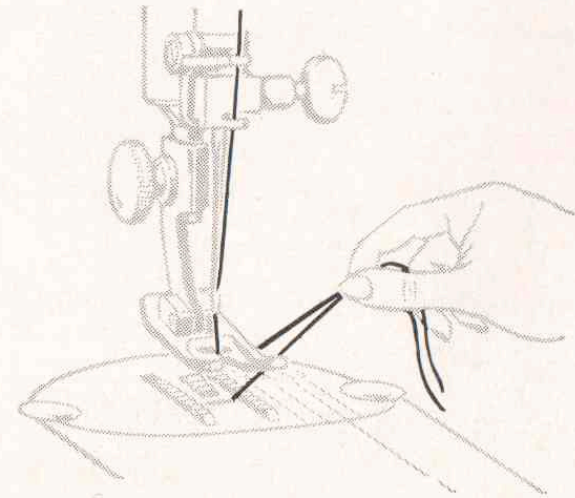

SEWING A SEAM

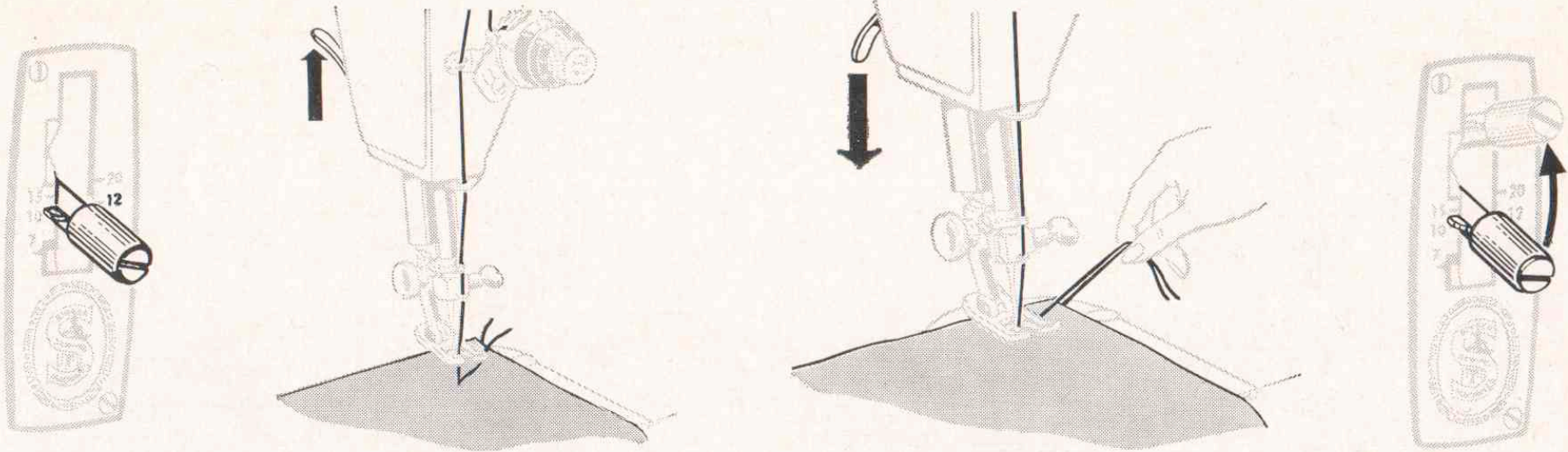

Set stitch regulator for stitch length desired. Position needle into fabric about $\frac{1}{2}$ inch from edge and lower presser foot. Raise stitch regulator to reverse.

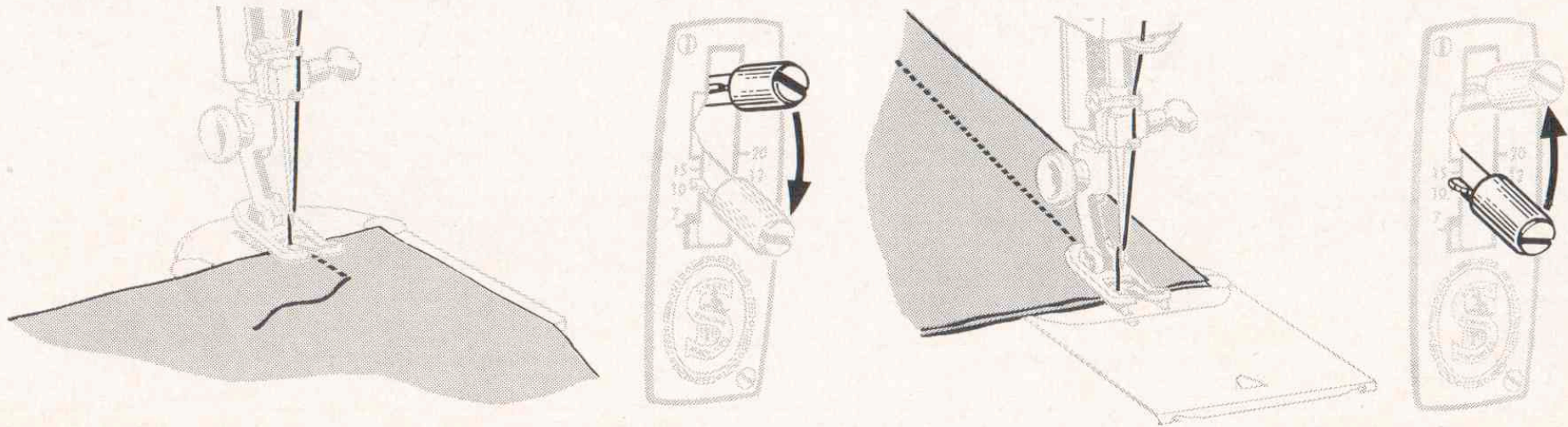

Back stitch to edge of fabric for reinforcement. Lower regulator for forward stitching of seam. Raise stitch regulator.

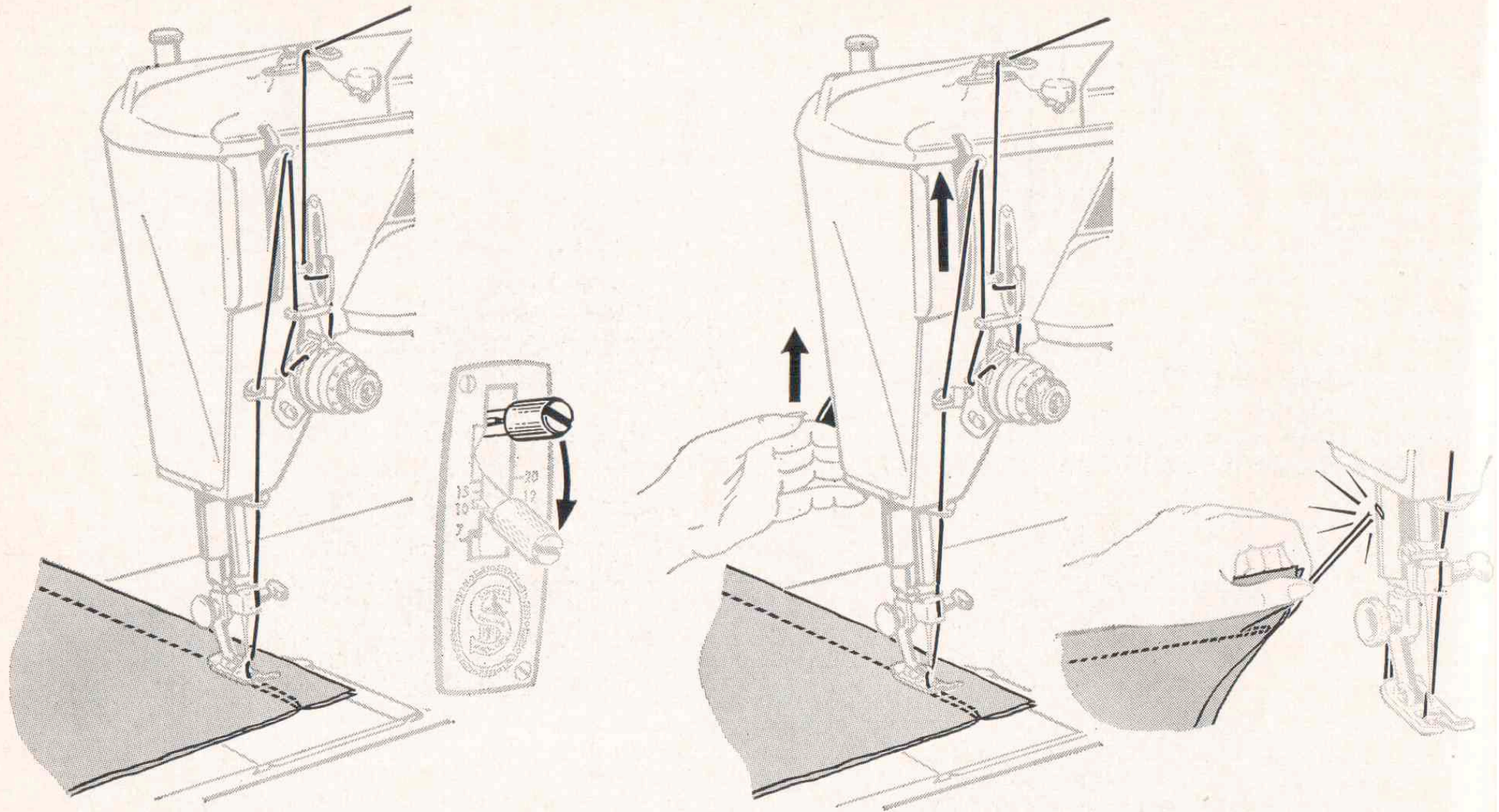

Back stitch to reinforce end of seam, and lower regulator to forward stitching position. With take-up lever at highest point, raise presser foot and remove fabric.

GUIDING AND SUPPORTING FABRIC

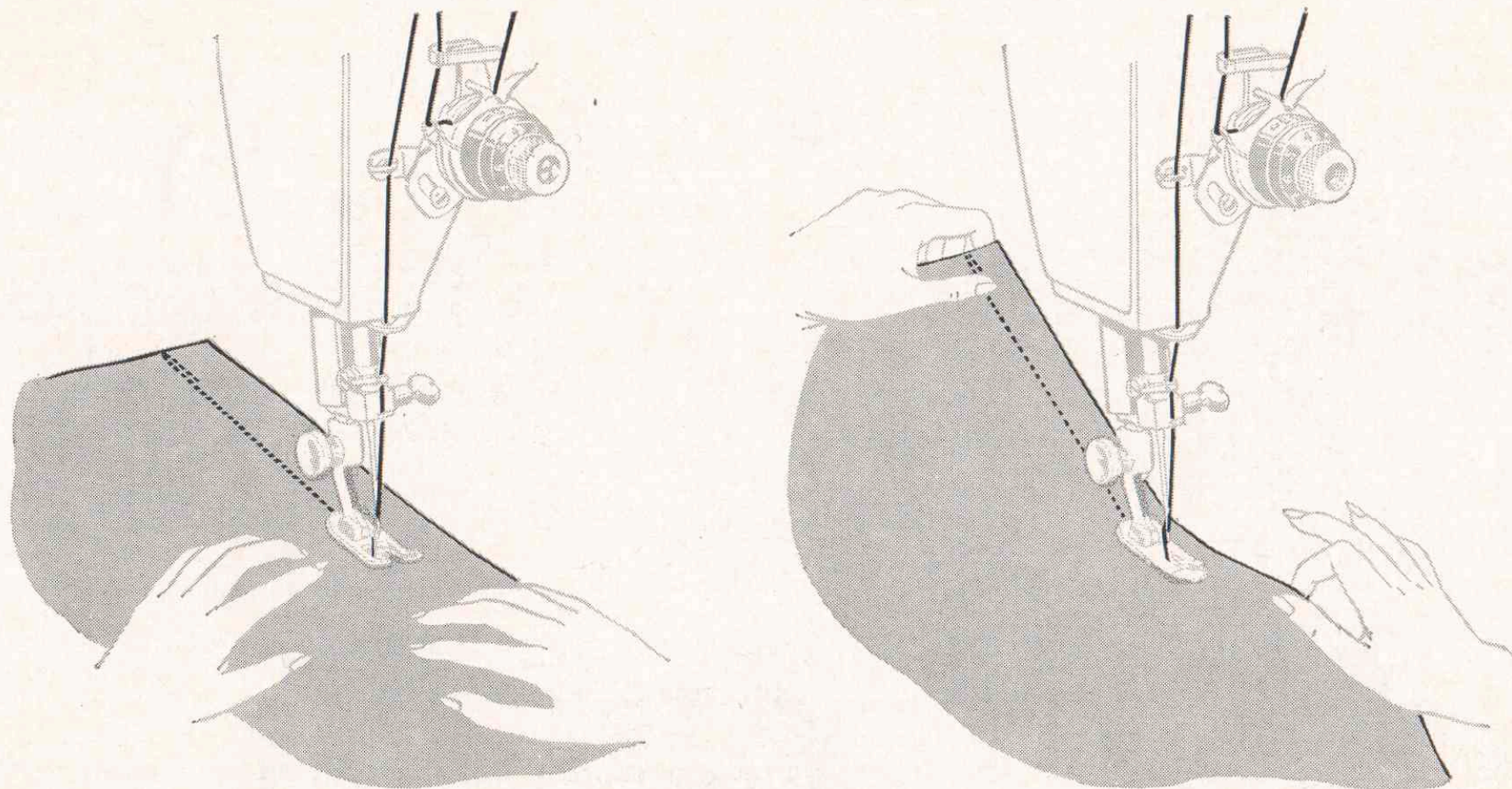

Most fabrics need only to be guided in front of the presser foot.

Fabrics of unusual texture and weave, filmy sheers, crepes, knits, tricots, etc., require support while being stitched.

For such fabrics, use the straight stitch throat plate and presser foot, and apply gentle tension to the seam by holding the fabric in front and in back of the presser foot as illustrated.

PRESSURE ADJUSTMENTS

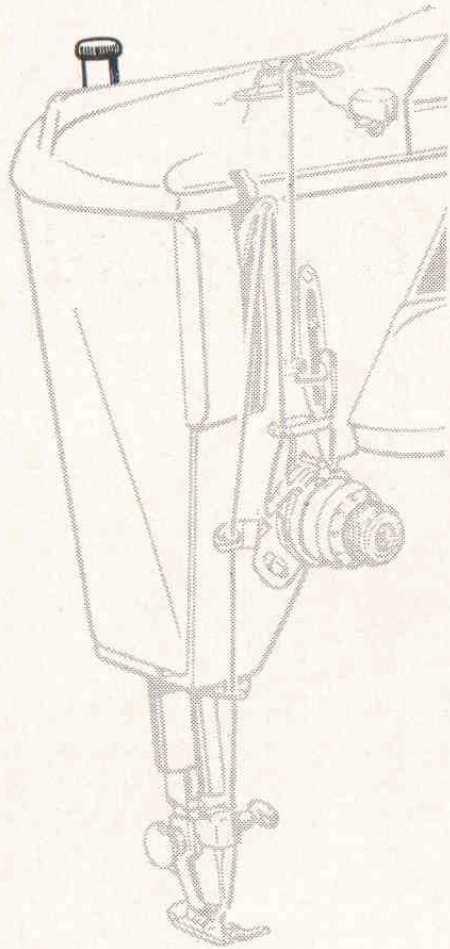

Decrease



Increase

To decrease pressure, turn thumb screw upward.
To increase pressure, turn screw downward.

Pressure is the force the presser foot exerts on fabric while it is being stitched.

Smooth, even handling of several thicknesses of fabric results when pressure is correctly regulated.

Too light a pressure will result in irregular feeding which affects both quality of stitch and evenness of seams.

Too heavy a pressure not only affects stitch and seam quality but will mar smooth surfaces and pile fabrics.

Surface finish, as well as the weight and texture of the fabric, must be considered in determining the amount of pressure needed.

NEEDLE THREAD TENSION STRAIGHT STITCHING

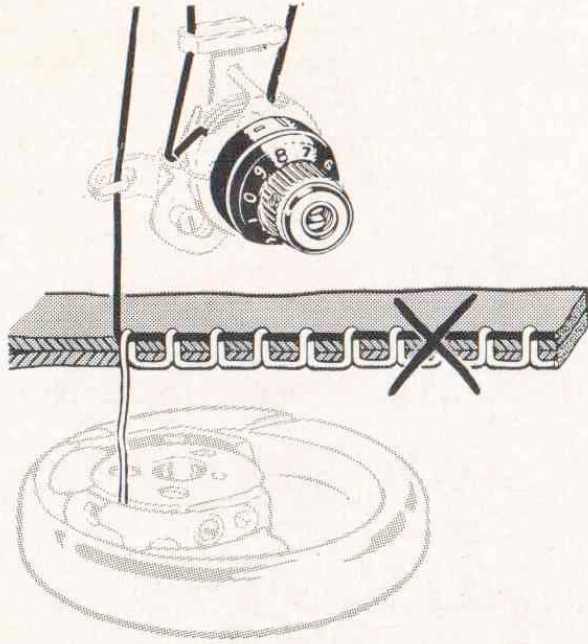

Needle thread tension too tight—
correct by setting dial to lower num-
ber.

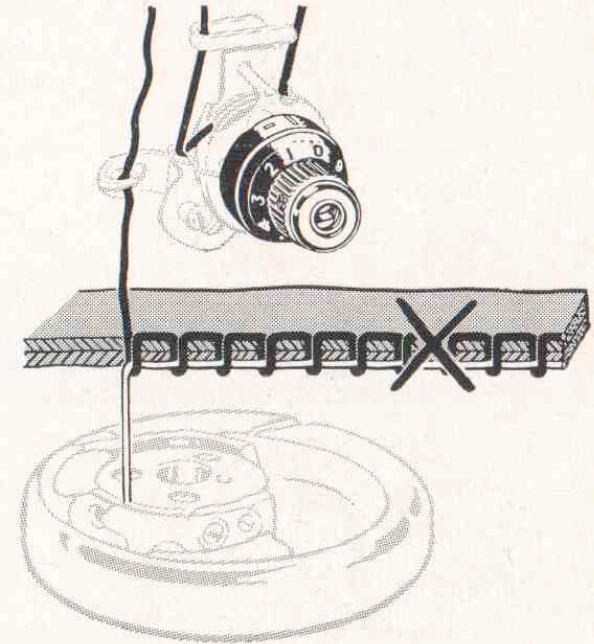

Needle thread tension too loose—
correct by setting dial to higher num-
ber.

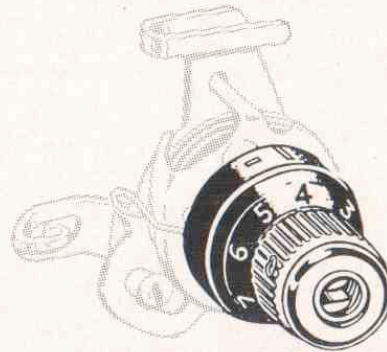

A perfectly locked stitch results with upper and lower tensions balanced so that needle and bobbin threads are drawn equally into fabric.

BOBBIN THREAD TENSION STRAIGHT STITCHING

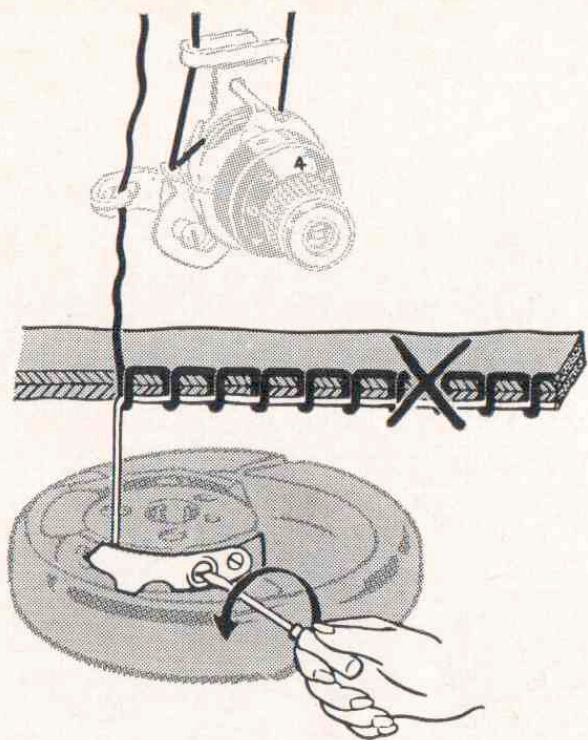

Bobbin thread tension too tight—
correct by turning screw in direction
indicated.

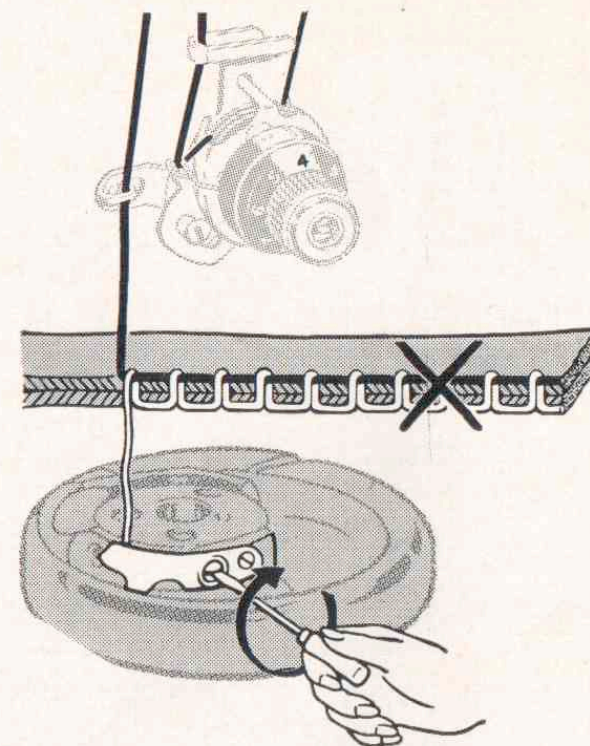

Bobbin thread tension too loose—
correct by turning screw in direction
indicated.



A perfectly locked stitch results with the upper and lower tensions balanced so that needle and bobbin threads are drawn equally into fabric.

ZIGZAG STITCHING EQUIPMENT

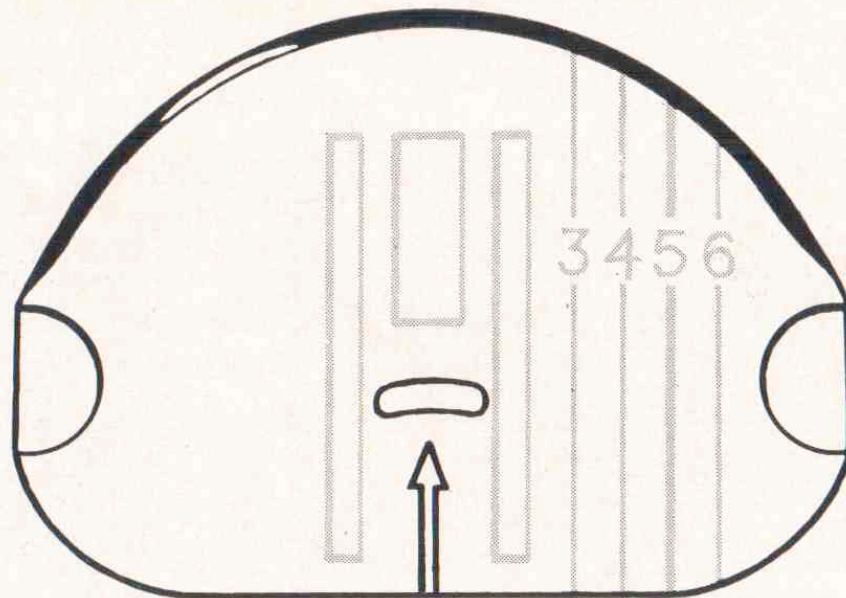

General purpose throat plate.



General purpose presser foot.

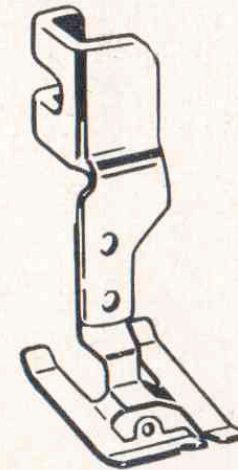

Special purpose presser foot.

STITCH LENGTH ADJUSTMENT FOR SATIN STITCHING

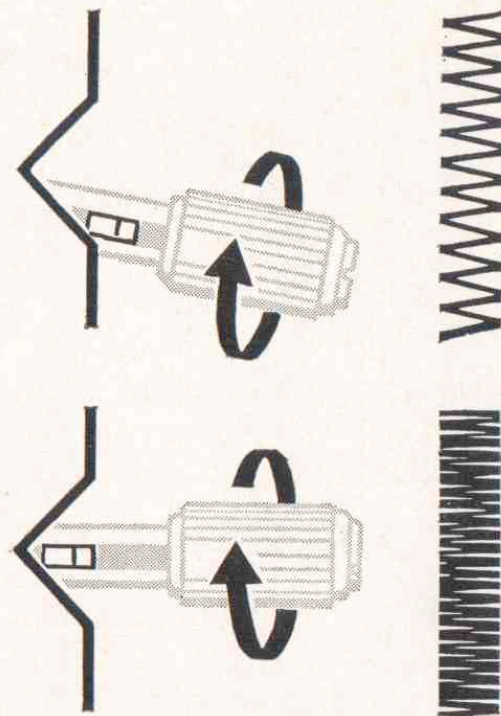
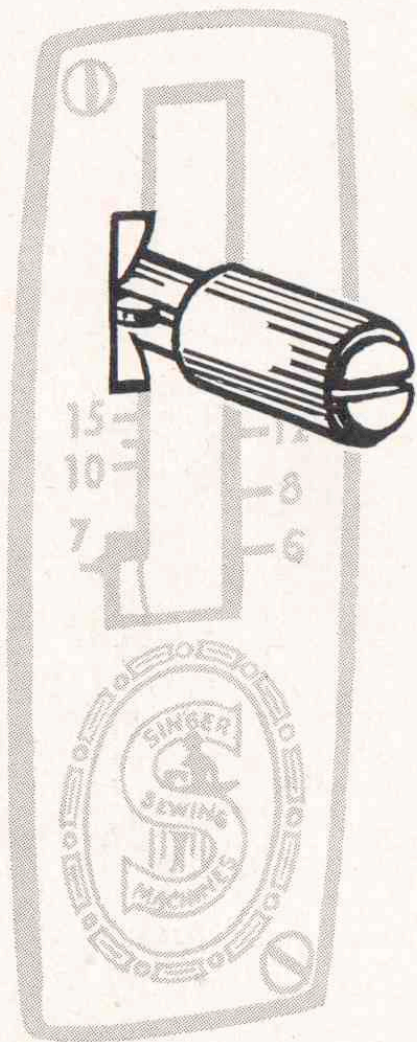

The upper indented area of the stitch indicator provides a means of gradually shortening the stitch length.

As the regulator knob is turned, the pointer rides deeper into this indentation until a closed satin stitch is obtained.

The exact stitch setting will vary with the texture of the fabric. It is advisable to make a test on a scrap of self fabric, using the Special Purpose Foot, before proceeding with the actual work.

SATIN STITCH TENSION ADJUSTMENT

Satin stitching requires a lighter needle thread tension than straight stitching or open designs. The wider the satin stitching the lighter the tension required.

Wide satin stitching, **Red Lever** at **5**, requires the least amount of tension. For narrower satin stitching slightly more tension should be used.

To determine correct tension setting, a test sample should be made on self fabric using the Special Purpose Foot. A properly balanced satin stitch should lie flat across the material. Any tautness or puckering indicates too high a needle thread tension.

Some soft fabrics may require the addition of a backing to insure good stitching results. Crisp organdy and lawn are suitable for this purpose.

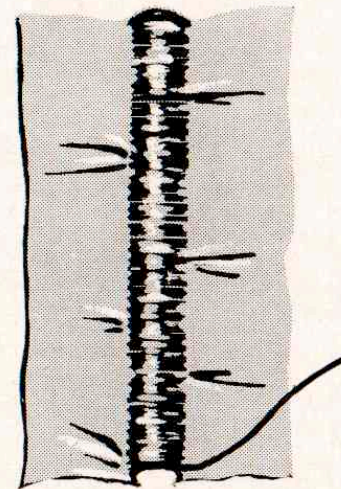
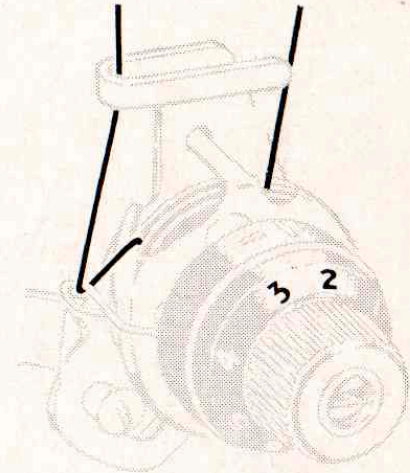
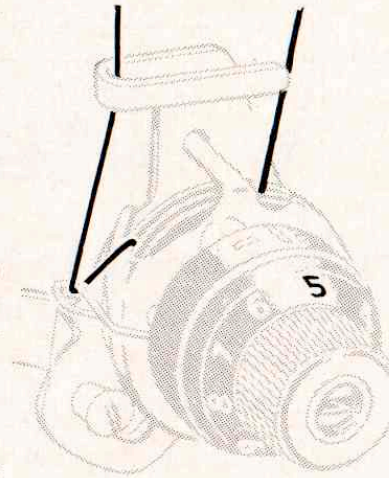

Tight needle thread tension

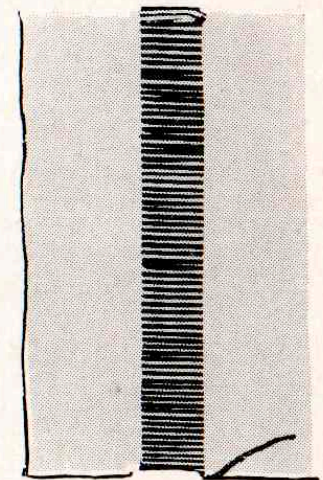

Correct needle thread tension

PRIMARY PATTERNS

See pages 18 and 19 for operation of Red Lever and Selector.

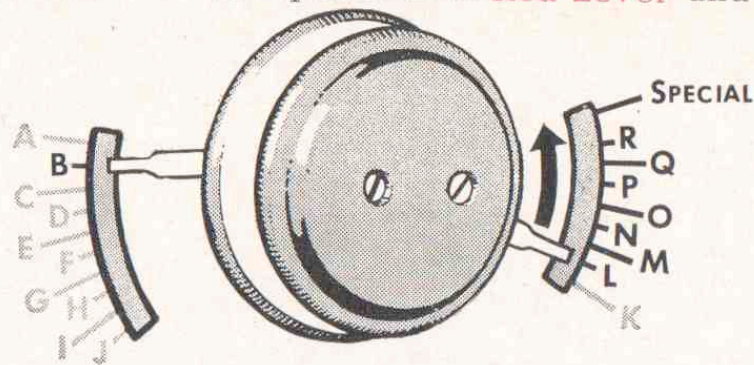

Selector settings L through special control primary patterns.
Selector setting B places stitching in central needle position.

Red Lever controls width of primary patterns.

Do not make selector or Red Lever adjustments while the needle is in the fabric.

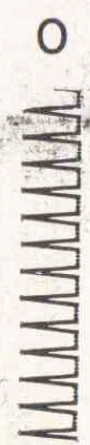

PRIMARY PATTERNS
SPECIAL DISCS

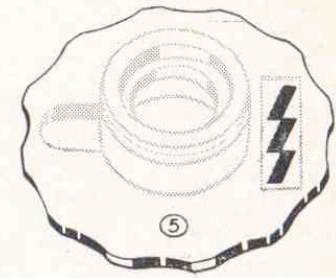
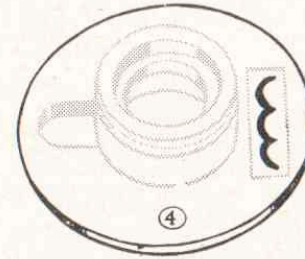
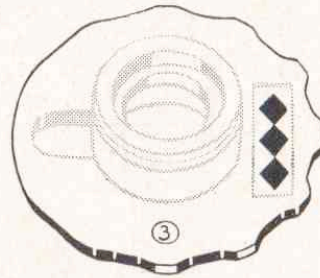
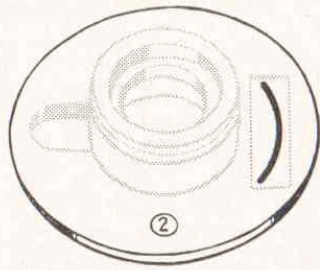
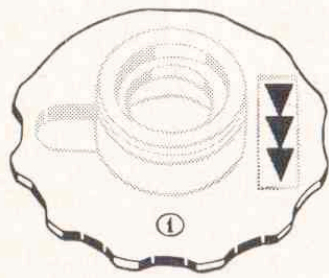

These five interchangeable Special Discs, classified as Primary Patterns, are included with the machine. Each produces an individual design.

Circled numbers (for example ②) in this book indicate Special Disc numbers.

PRIMARY PATTERNS REPLACEMENT OF SPECIAL DISCS

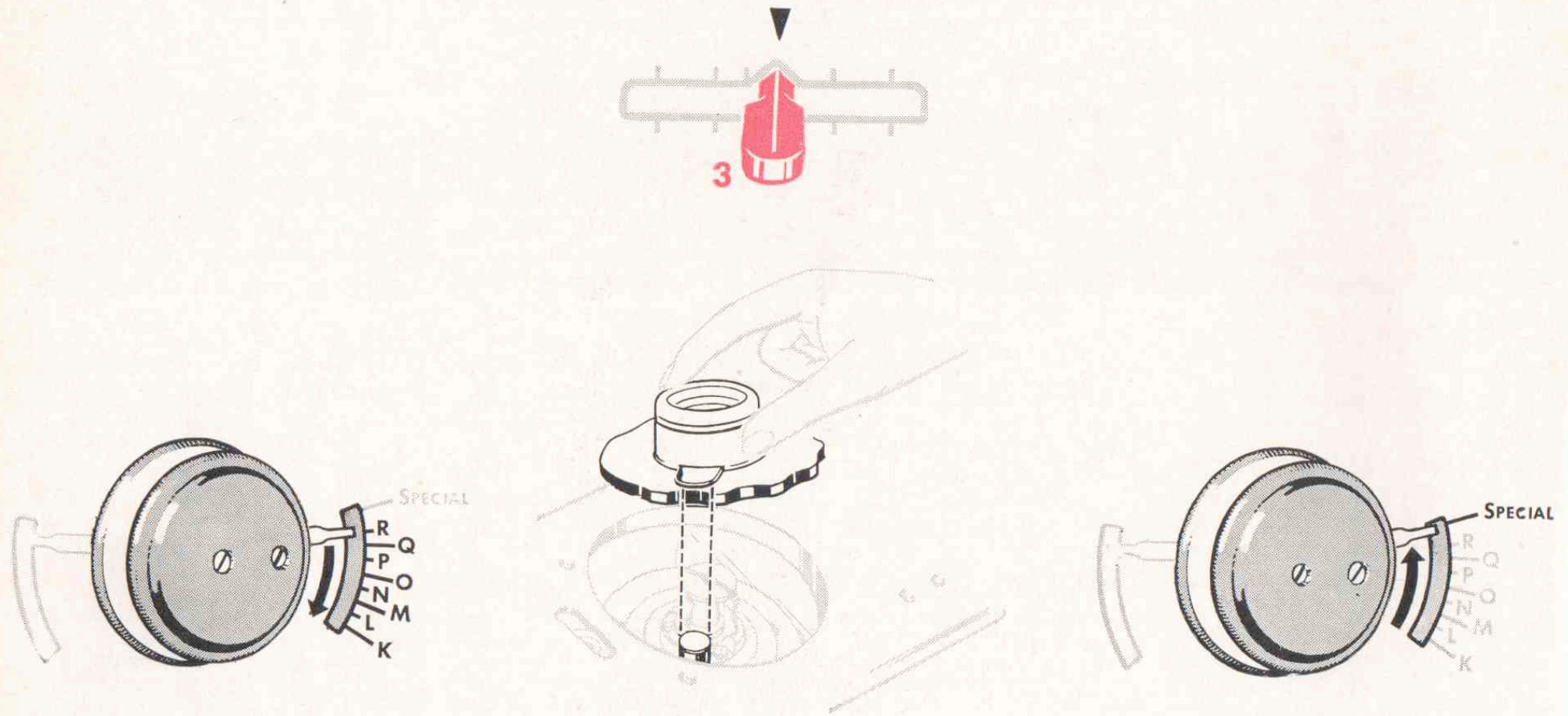

To replace any of these discs, move right hand pointer of Selector off Special.

Raise the stitch chart at top of the machine. Remove disc and place another disc onto spindle, pushing downward until disc snaps in place.

Set right hand pointer on Special to engage the disc.

PRIMARY PATTERNS
RED LEVER CONTROL OF WIDTH

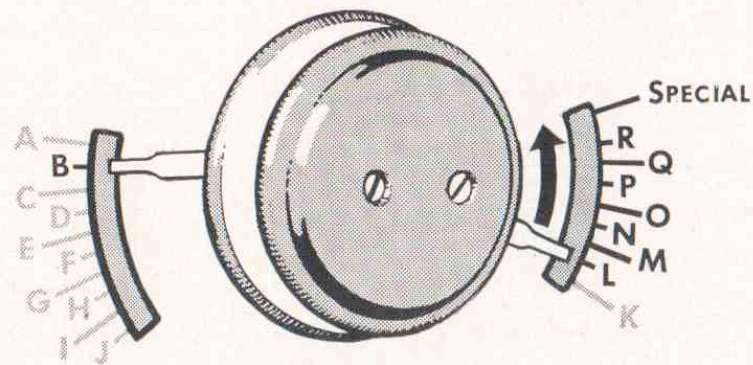
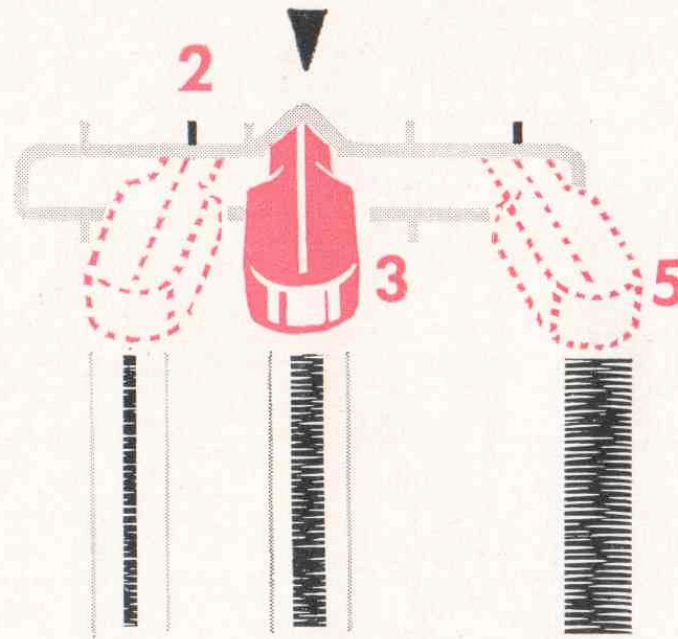

The width of Primary Patterns is controlled by the **Red Lever**. Settings range from a maximum of **5** to a minimum of **2**.

PRIMARY PATTERNS NEEDLE POSITIONS

Selector setting of B places stitching in central needle position. Selector settings A and C place the stitching in left and right needle positions at widths less than 5.

LEFT **A** 

CENTRE **B** 

RIGHT **C** 

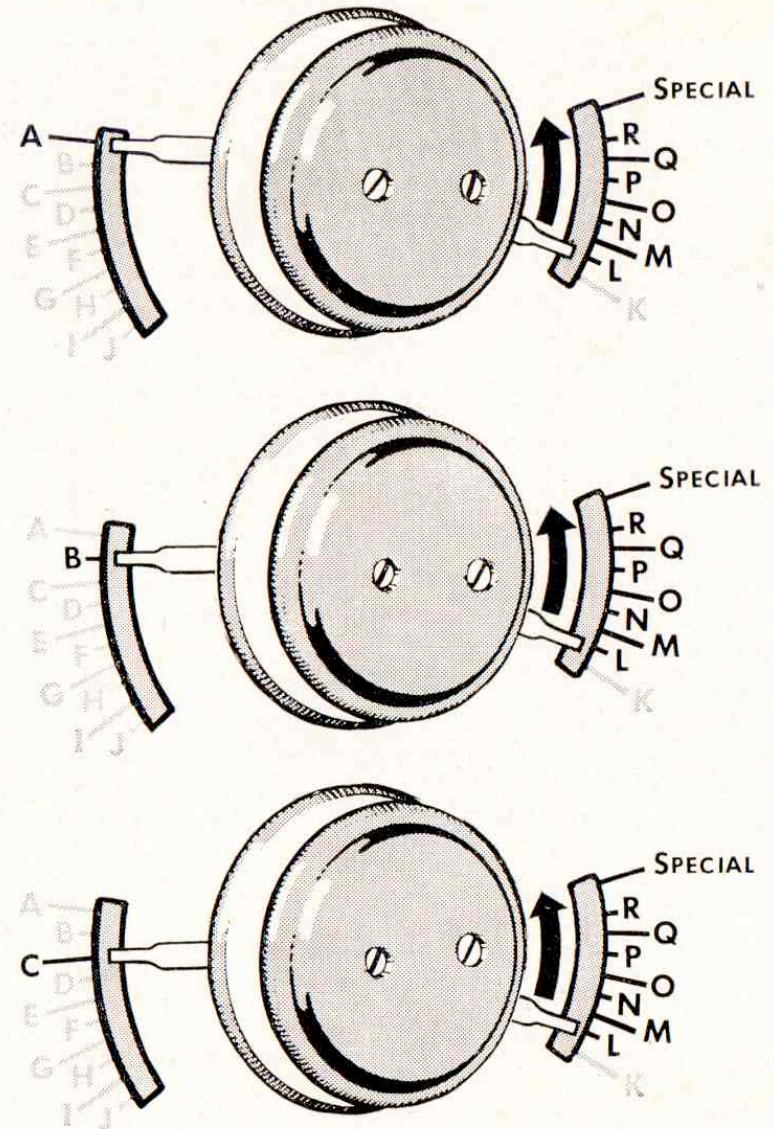
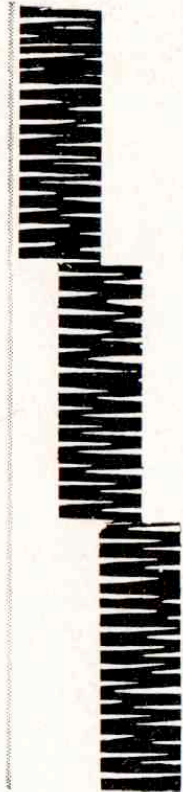

Selector setting B is preferred. Settings A and C are only used when special placement of stitching is desired. For example: buttonholes, button sewing, blind stitching.

COMBINATION PATTERNS AND VARIATIONS

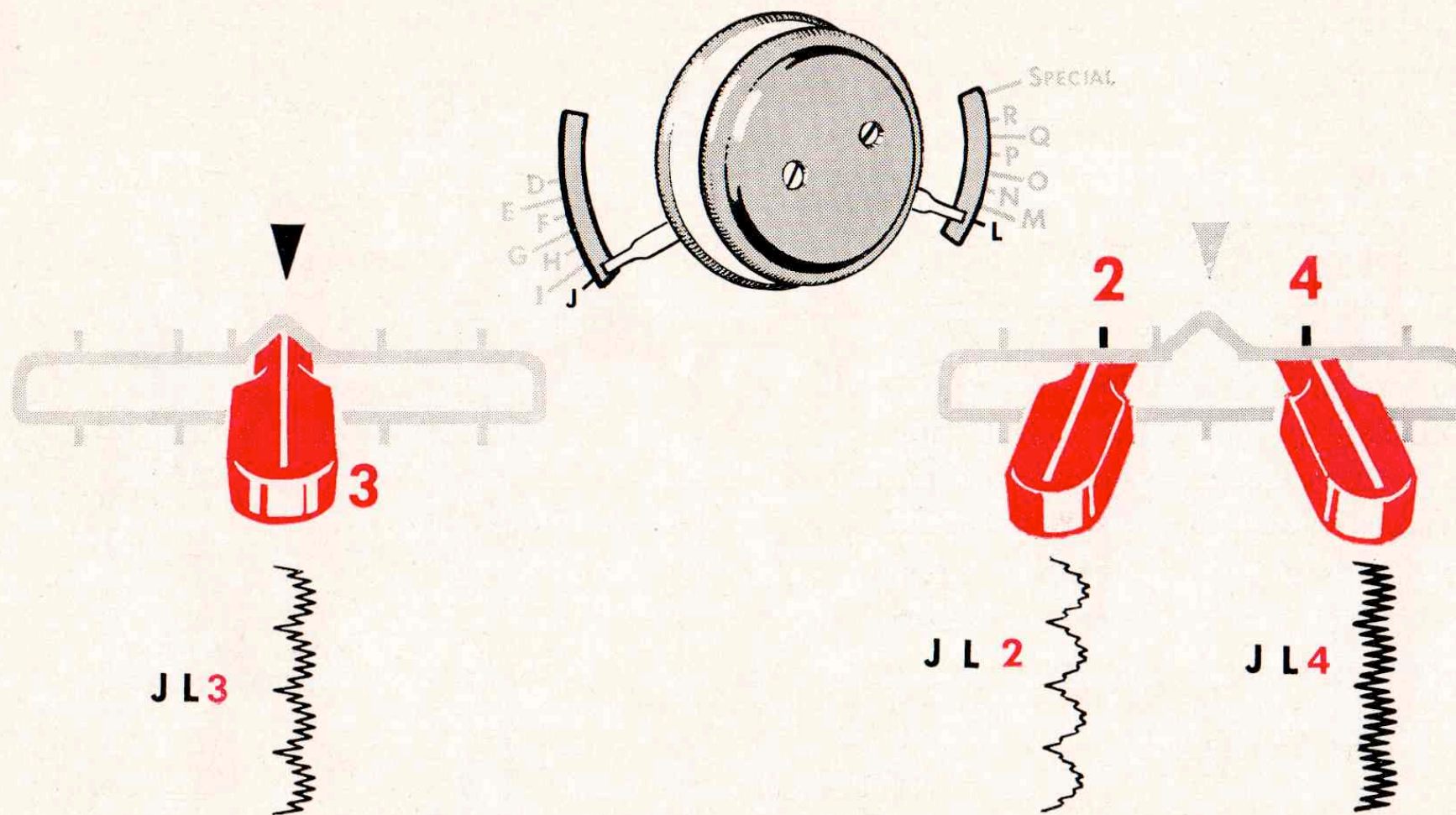

A great variety of additional stitch patterns can be created by combining any left hand Selector setting from D through J with any right hand Selector setting from L through Special.

A **Red Lever** setting of **3** results in a Combination Pattern. Settings of **2** and **4** produce Variations.

TWO NEEDLES

The needle clamp accommodates two 15 x 1 needles, generally of the same size. However, where special effects are desired, needles of different sizes may be used together, with corresponding threads. Loosen the thumb screw and insert the additional needle from the right. (See **page 6** for procedure.)

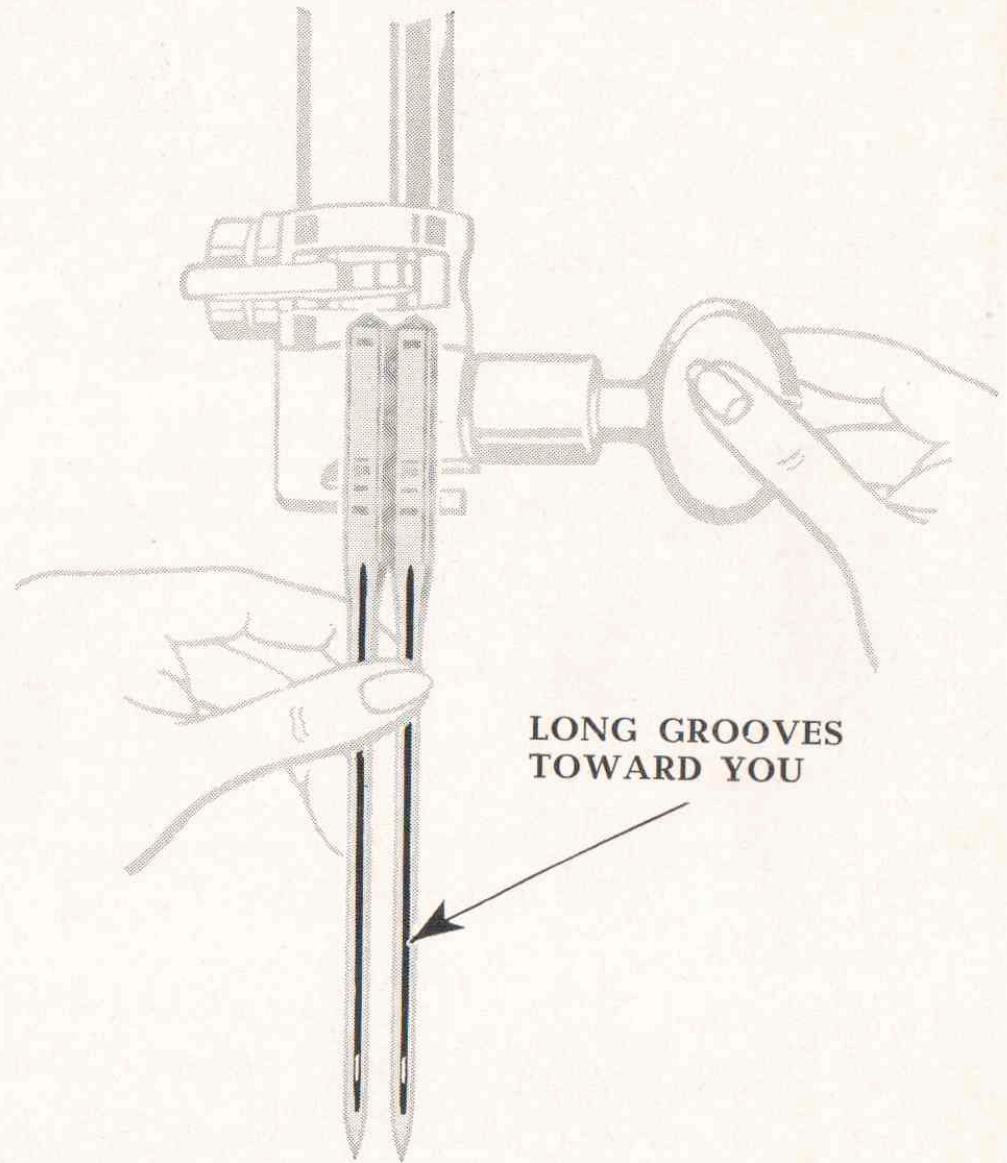

TWO NEEDLES UPPER THREADING

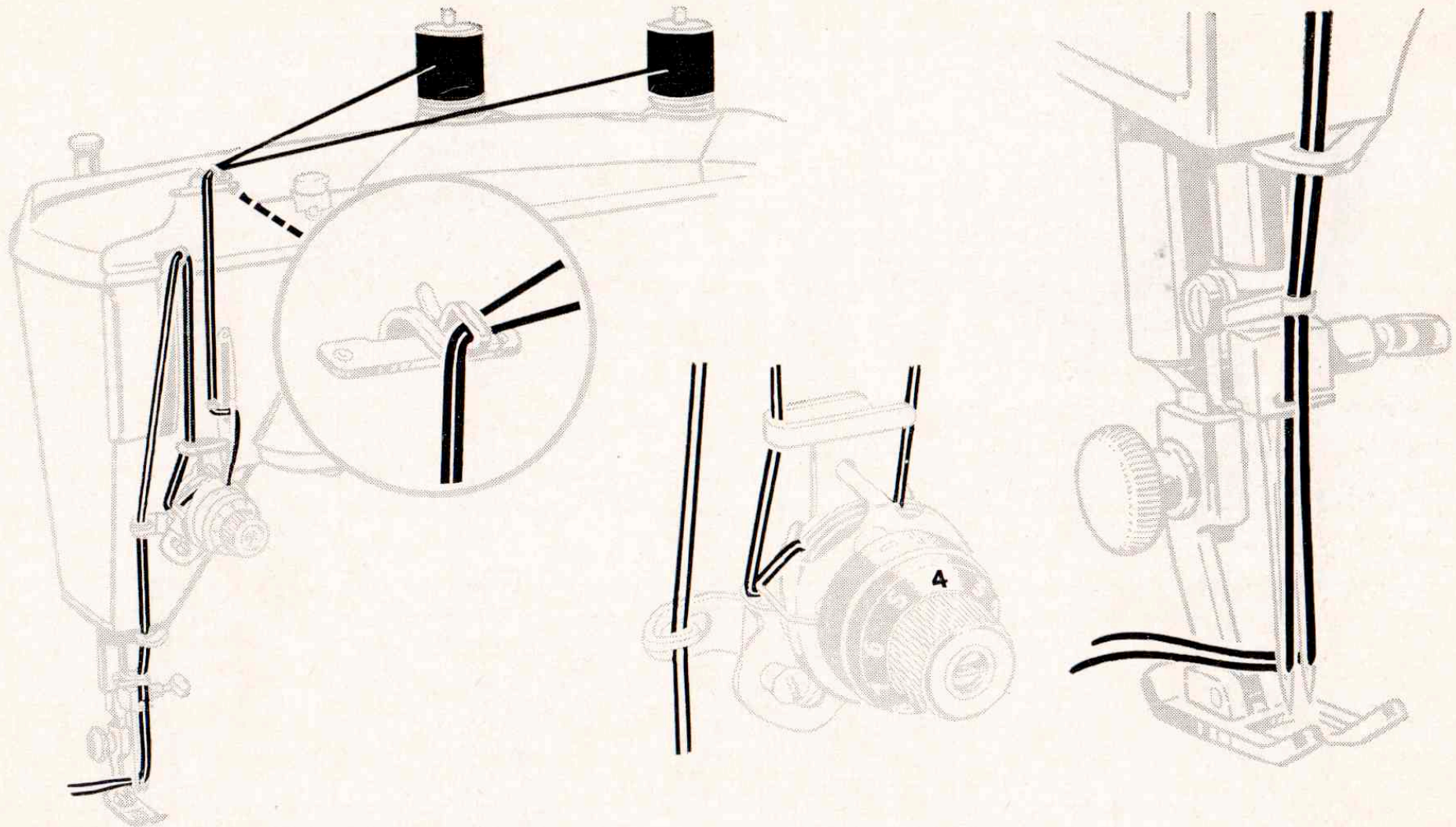

Use size 50 mercerised cotton thread.

Thread as for single needle (see **page 10**). Be sure threads are separated by the centre tension disc. Carry only one thread through the last guide before the needle.

TWO NEEDLES
STRAIGHT STITCHING A K 2

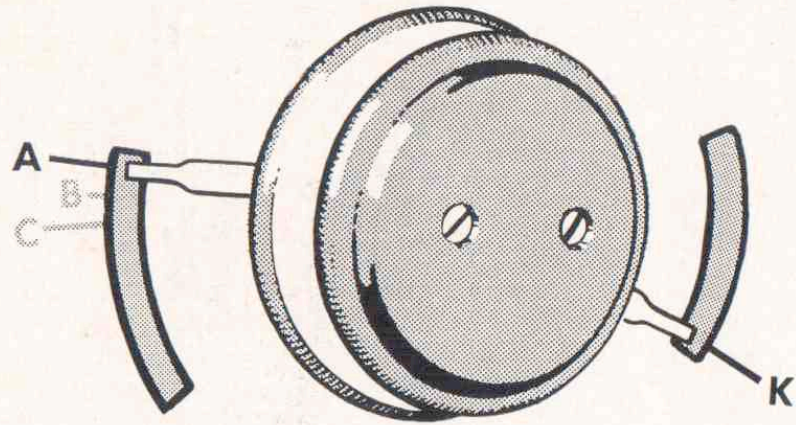

Selector setting: A K.

Red Lever: 2 only.

General purpose foot and throat plate.

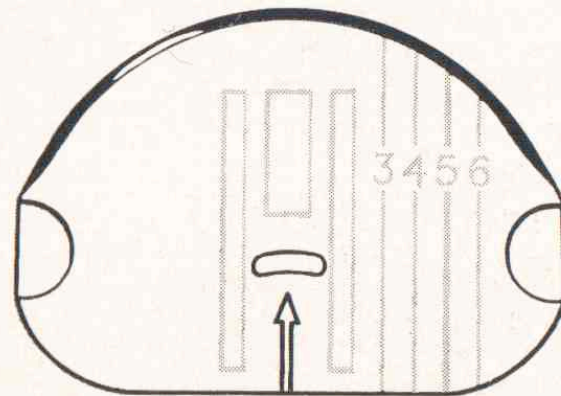
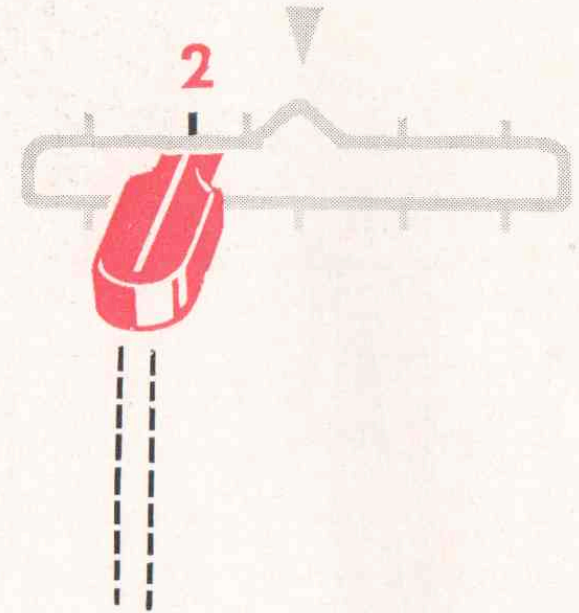

TWO NEEDLES PRIMARY PATTERNS

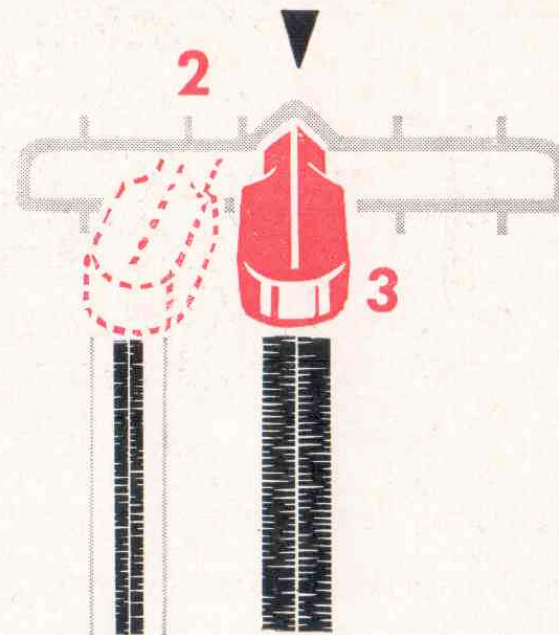
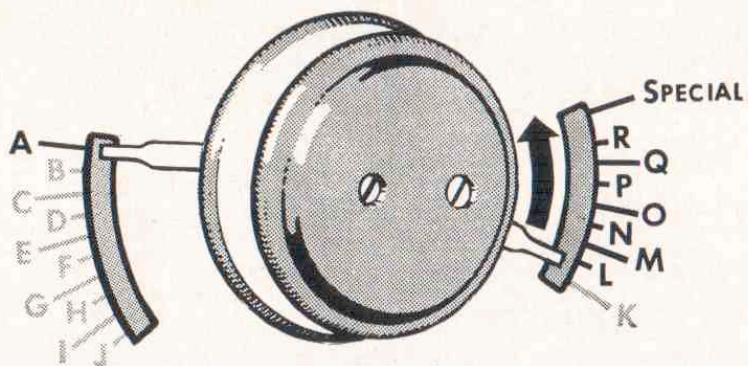

Selector setting: A - L through special.

Red Lever: 2 or 3 maximum.

General purpose throat plate.

General purpose foot or special purpose foot.

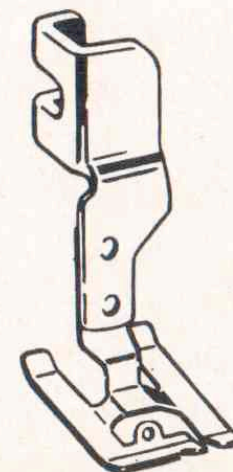
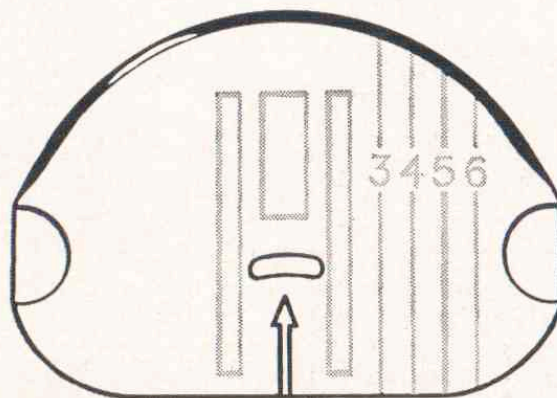
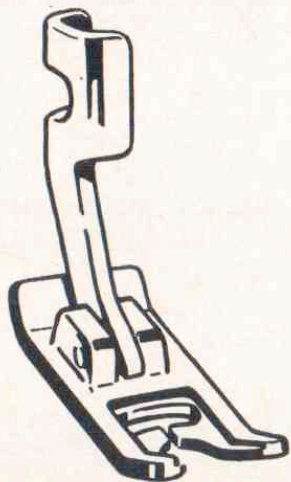

SPECIAL PURPOSE FOOT

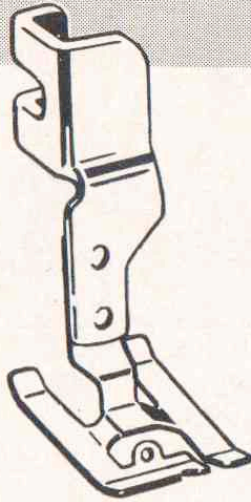

This light, flexible foot is designed for satin stitching. It provides maximum visibility and maneuverability while allowing closely spaced zigzag stitches to feed freely.

It is ideal for accurate placement of satin stitching in buttonholes, monograms, motifs and applique work.

The eyelet on the left side of the foot accommodates a filler cord.

APPLICATIONS

Buttonholes
 Applique
 Monograms

Decorative Stitching
 Couching
 Motifs

BUTTONHOLES

Selector: AL

Red Lever: See below

Throat plate: General purpose

Special purpose foot

Stitch length: Fine

To establish the correct stitch setting and length of buttonhole, a sample must first be made.

Three Red Lever settings are available. Fabric weight will determine the selection.

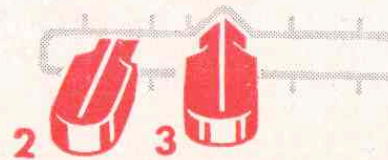
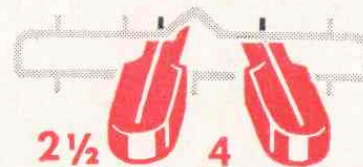

BUTTONHOLES

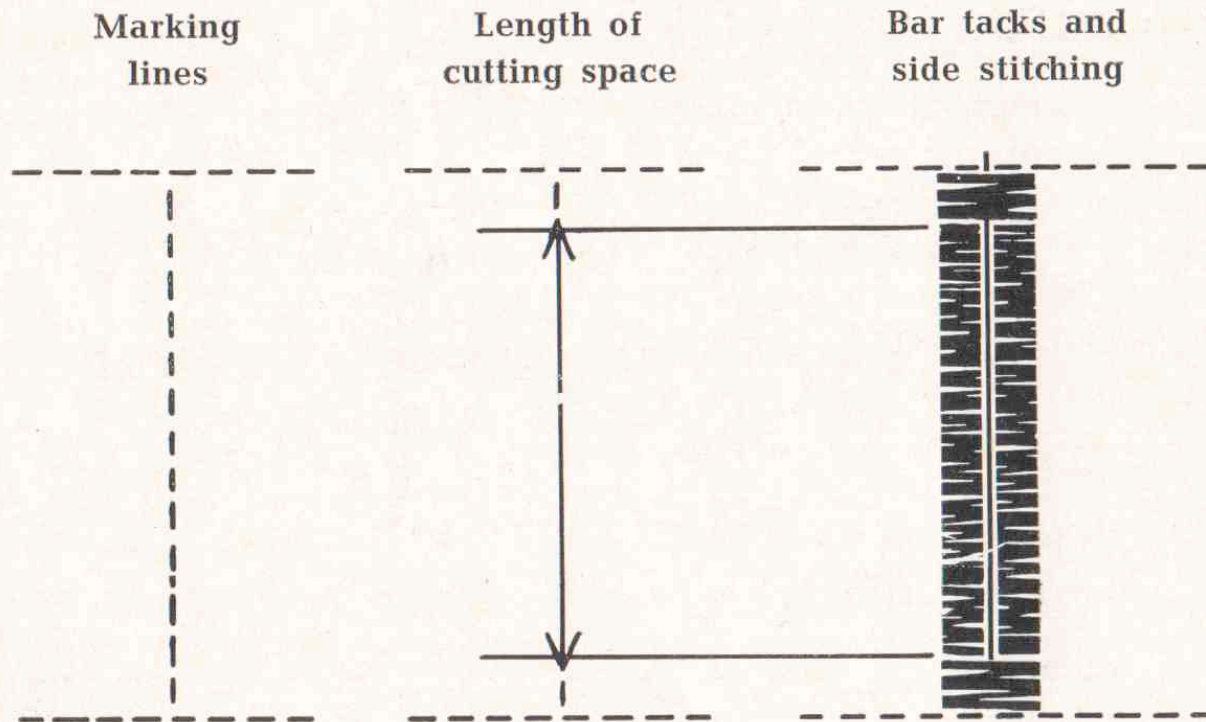

The length of cutting space, the opening through which the button passes, is measured by the width and thickness of the button.

The length of the finished buttonhole will be the cutting space plus $\frac{1}{8}$ inch for bar tacks.

Work a sample buttonhole in the same fabric as the garment. Use a double fold, duplicating a facing, and include interfacing if this has been used.

BUTTONHOLES

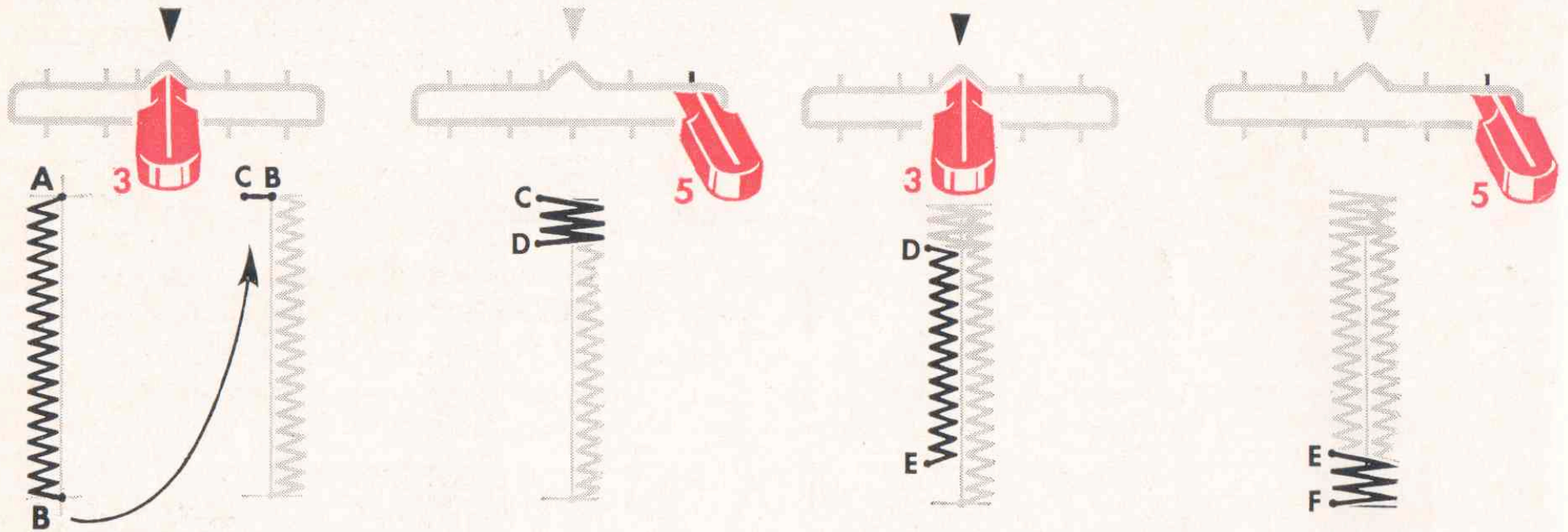

Stitching Procedure. Set Selector and **Red Lever**. Place work under the needle, aligning the centre marking of buttonhole with centre score line of foot.

To form side stitching, turn hand wheel toward you so the needle enters fabric at point **A**. Lower foot and stitch to end of marking. Leave needle in fabric at point **B**. Raise foot, pivot work on needle. Lower foot. Take one stitch without changing **Red Lever** setting, bringing work to point **C**. Adjust to **Red Lever** setting for bar tacks and take no less than six stitches. Stop at point **D**. Readjust to **Red Lever** setting for side stitching. Complete to point **E**, or approximately six stitches from the end of the buttonhole. Move to **Red Lever** setting for bar tacks and duplicate tack previously made, ending at point **F**.

BUTTONHOLES

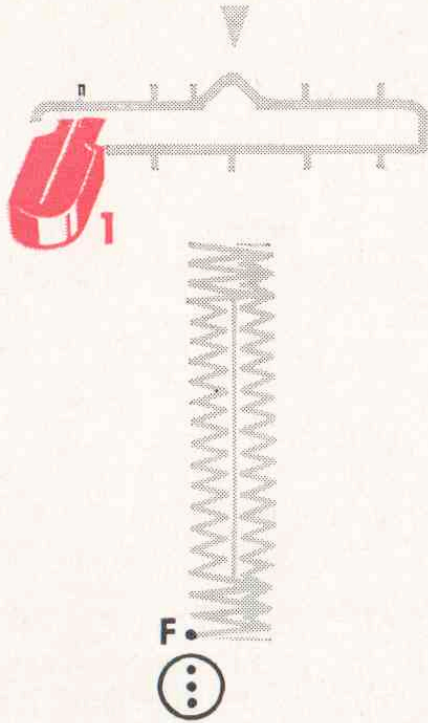

To secure stitching move **Red Lever** to **No. 1** setting and take three stitches. Remove work, draw threads to the underside, fasten and trim.

With sharp embroidery scissors cut opening for button.

Raised or Corded Buttonholes. Both No. 8 pearl cotton and buttonhole twist make suitable filler cords for raised buttonholes.

Place the spool of filler cord on the second spool pin. Carry the cord through the first thread guide, straight down between the centre and back tension discs, into the large thread guide and then through the eyelet on the Special Purpose Foot. Draw the cord under and in back of the foot and proceed as for regular buttonholes.

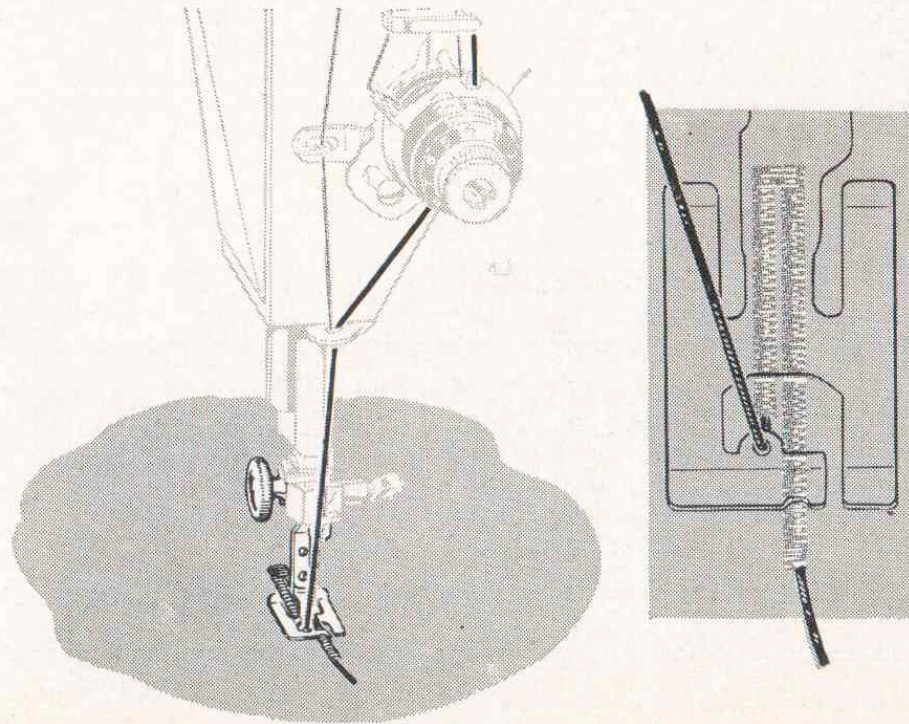

APPLIQUE

Applique adds beauty and interest to wearing apparel, linens and fabric furnishings.

Either contrasting or self fabric may be used effectively. The most versatile stitch in appliqueing is a closely set zigzag stitch (Primary Pattern BL). The width of this stitch may be varied to accommodate weaves and textures of fabrics. Combination Patterns and Variations present many interesting ways to applique with decorative stitching.

Preparation. There are two methods by which applique work may be done. The appropriate method is determined by the fabric being used, and a test sample is advisable.

Position the design properly and baste it to the fabric. Attach the Special Purpose Foot to the presser bar.

Method No. 1. Set Selector and **Red Lever** for the desired stitch pattern. Following the shape of the design, outline it entirely with applique stitching. Any excess fabric on the outer edges is trimmed away after the stitching has been completed.

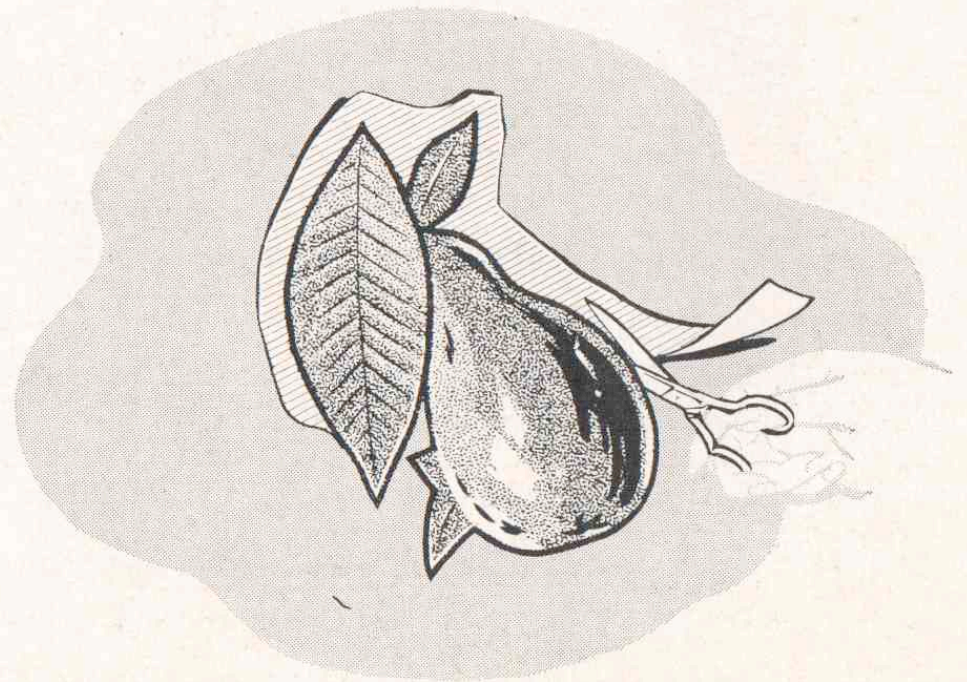

APPLIQUE

Method No. 2. Set Selector and **Red Lever** to AK 3 for straight stitching. Outline the entire design with a short stitch. Trim the raw edges down to the stitching.

Set Selector and **Red Lever** to the stitch pattern desired, and overedge the design with this stitching. A smooth, lustrous finish results, which requires no additional trimming.

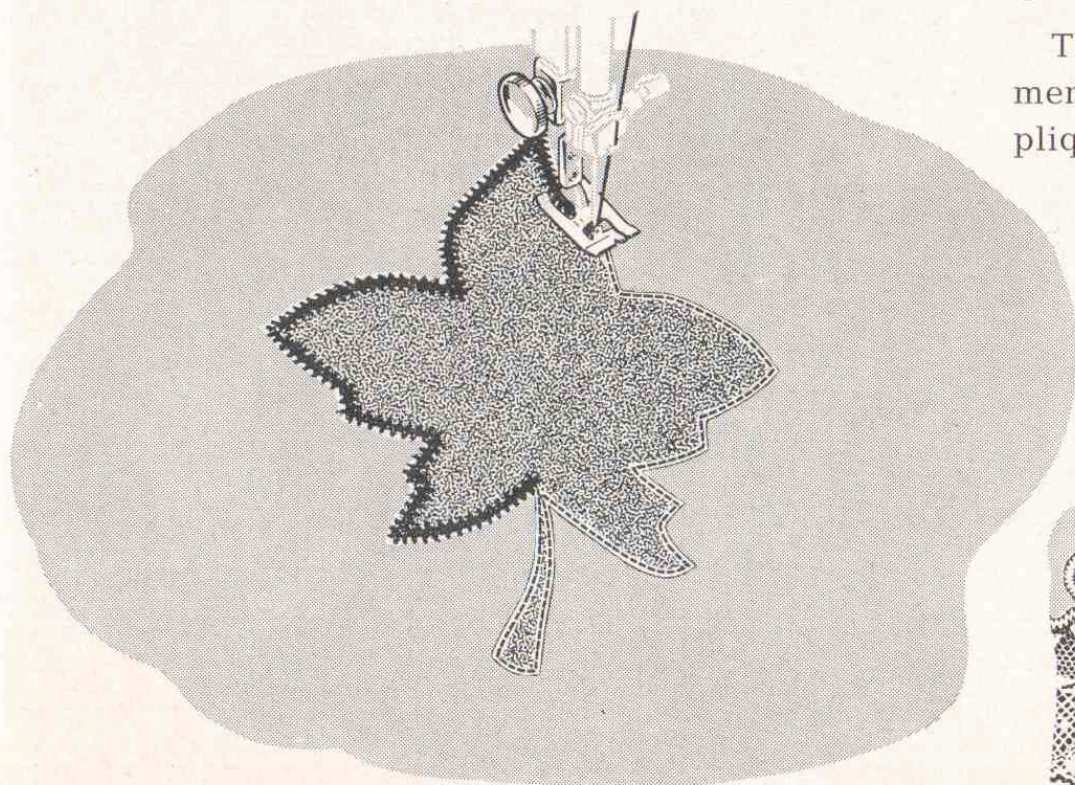

Corded Applique. The Special Purpose Foot, which provides for a filler cord, is perfect for corded applique work. Gimp, crochet thread or button-hole twist are generally used.

See **page 47** for threading.

Either method of appliqueing may be used when cording is desired. The only change in procedure is the introduction of the cord, over which the applique stitching is formed.

This stitching technique results in a raised, dimensional effect, and is an ideal finish for lace applique.

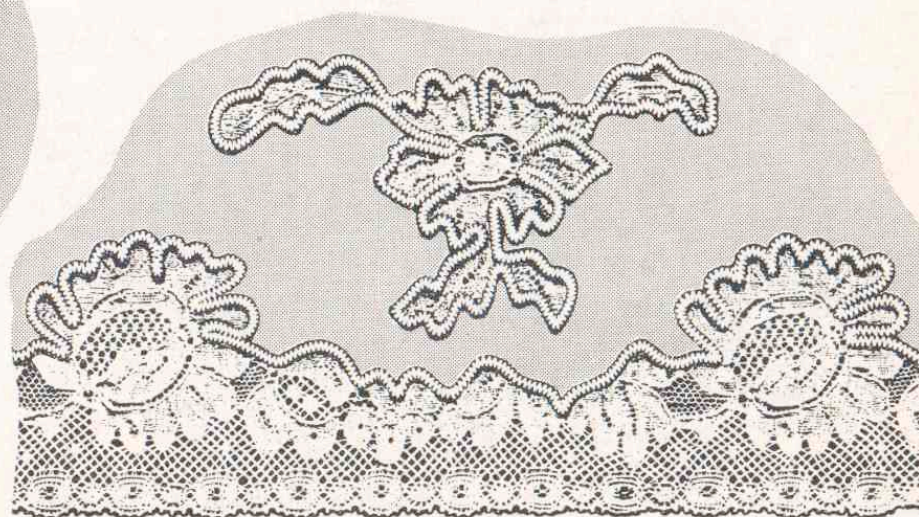

MONOGRAMS AND MOTIFS

Any of the many stitch patterns are perfect for monograms and motifs.

Select a design from the many transfer patterns available or sketch one to suit your purpose.

Some fabrics may require a backing of lawn or organdy.

Position the design on the right side of the material. Trim backing away when stitching is completed, if necessary.

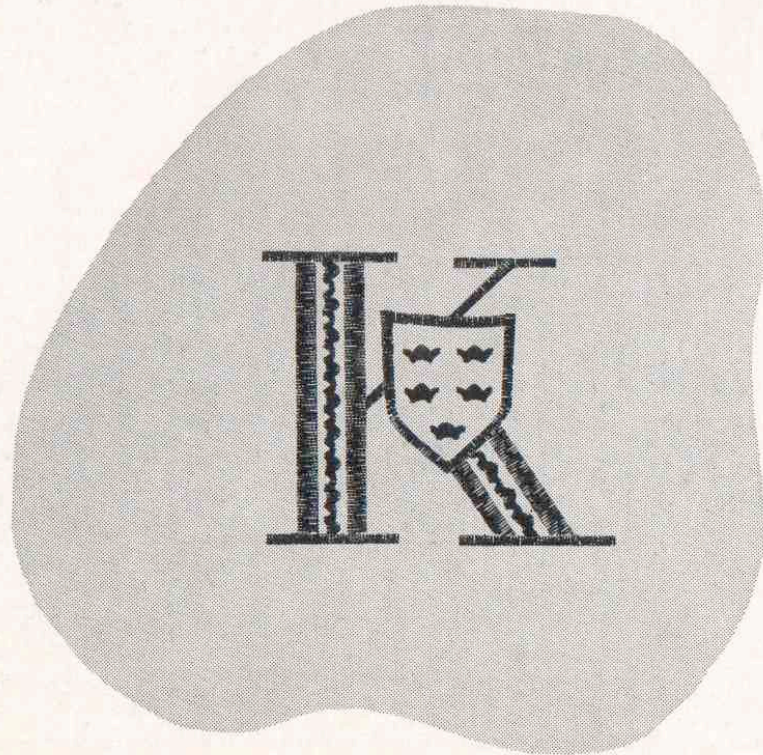

To reproduce a specific portion of a stitch pattern, first stitch on a scrap of material until the desired point in the design is reached.

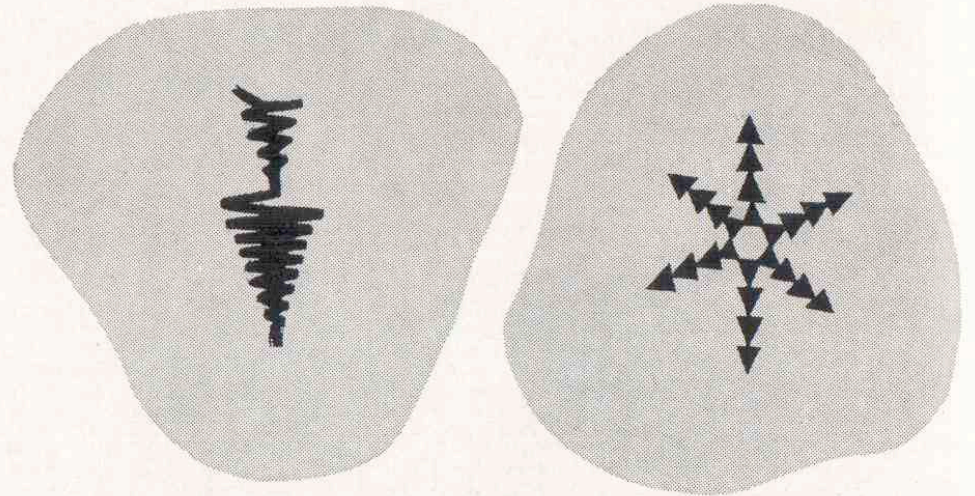

Remove the material from under the presser foot. Now position motif or monogram under the needle. Lower presser foot and stitch.

This procedure is recommended for all precise design placement. Leaves, and flower petals, for example are created in this way.

SEAMING SHEERS

Selector: B L

Red Lever: 2

Throat plate: General Purpose

Special purpose foot

Stitch length: Fine (above 25)

A dainty hair-line finish is particularly desirable for the inside seams of sheer collars, facings and yokes. Seam allowances that ordinarily show through are eliminated.

Both heavy duty thread and tatting thread make suitable filler cords (see **page 47** for threading). Follow the seam outline covering the cord. Cut away seam allowance close to line of stitching.

Turn and press.

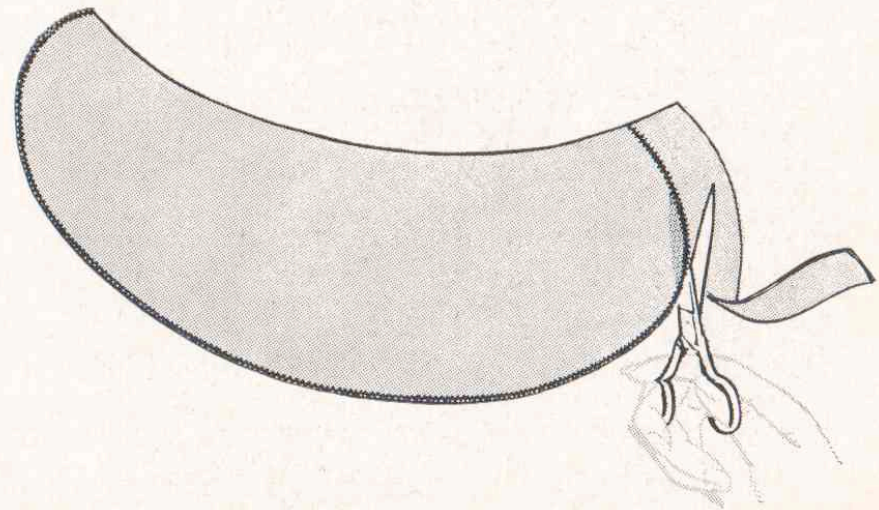
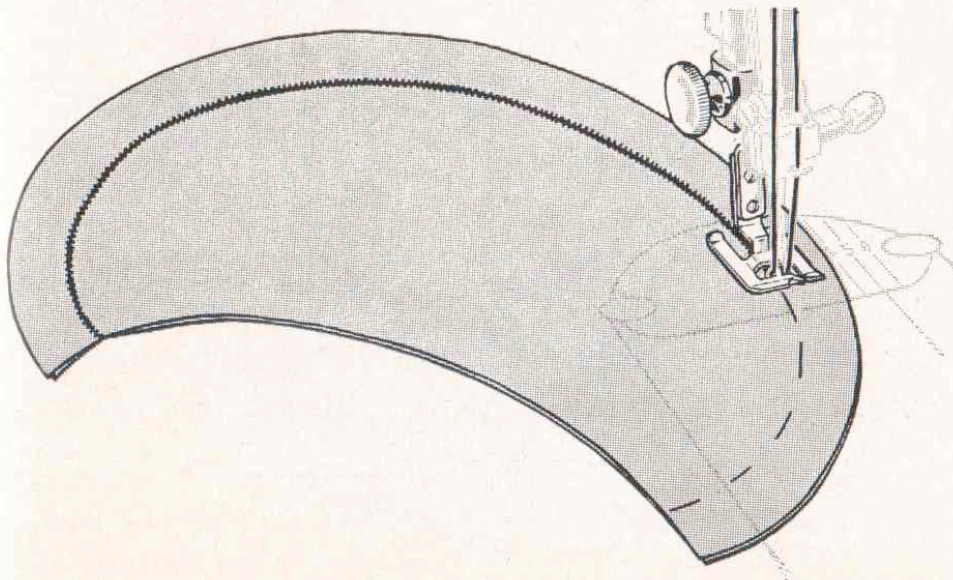

COUCHING

Novel effects are obtained by couching gimp, yarn or braid with stitch patterns.

Spaced patterns are the most appropriate as they allow the decorative cords to show as part of the design.

The Special Purpose Foot is ideally suited to this work.

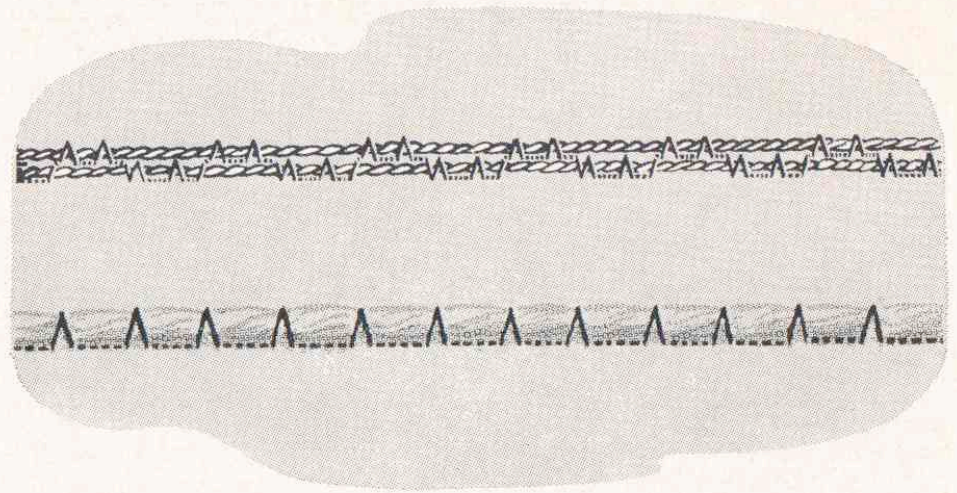

LACE EDGING AND INSERTION

Delicate and Durable zigzag stitching is especially appropriate for the application of lace edgings and insertions.

Many decorative stitch patterns can be used effectively serving as both finish and trim.

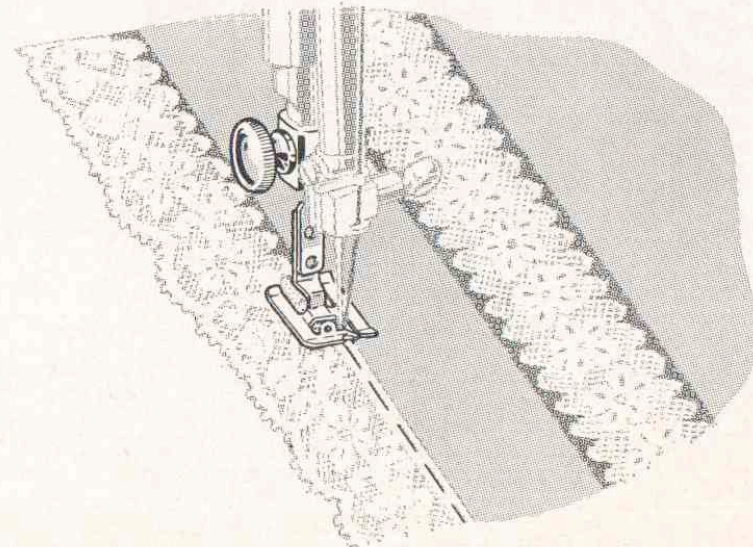

BUTTON SEWING FOOT



This short, open foot accommodates any size sewthrough button, and holds it securely for stitching. The groove in the foot allows for insertion of a machine needle, over which a thread shank may be formed.

Selector: AL

Red Lever: 1 and 4

Throat plate: Raised

General purpose

Button sewing foot

The space between the holes in the button determines the **Red Lever** settings. Numbers **one** and **four** generally apply to standard buttons. The number **one** setting is constant, but **four** can be increased or decreased to accommodate buttons with unusual spacing.

Set Selector at AL and **Red Lever** at **1**. Raise throat plate. Position button under foot so that needle will enter into left hole. Lower foot. Turn hand wheel toward you until needle rises out of fabric and is just above the foot.

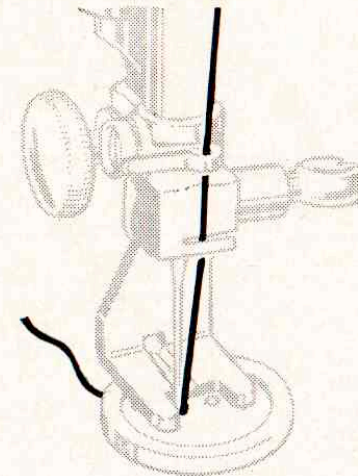
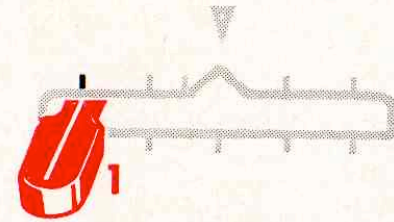

BUTTON SEWING FOOT

Set **Red Lever** at **4**. The needle should then enter into the right hole of the button. Take approximately six zigzag stitches in this position. End on the left side.

To fasten stitching, adjust to number **one Red Lever** setting and take approximately three stitches.

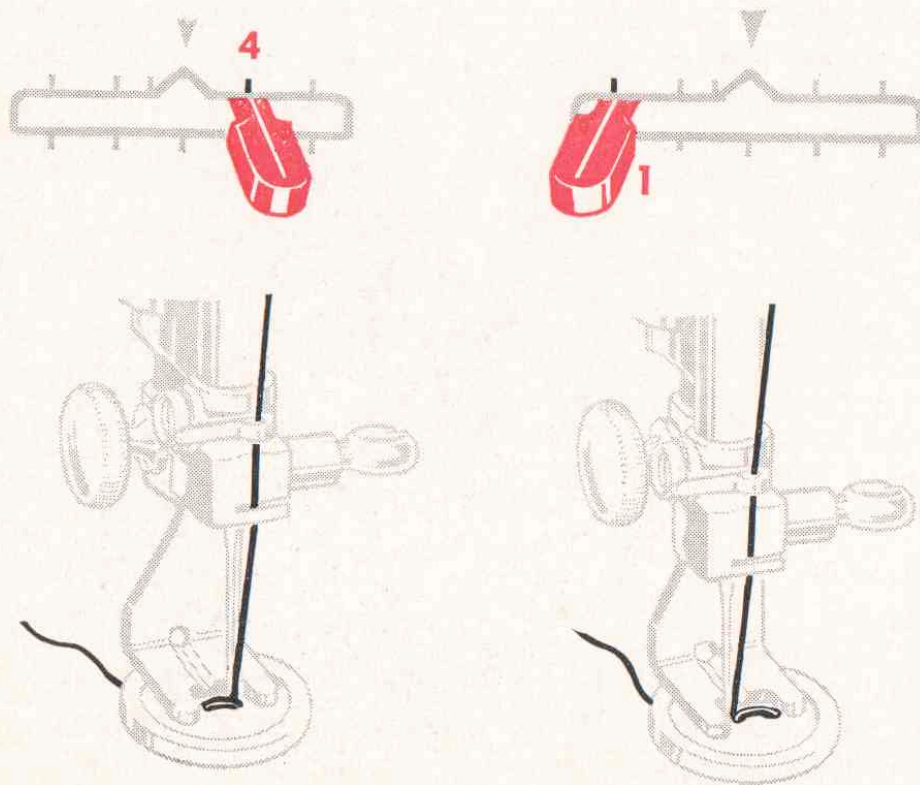

THREAD SHANK

In order to form a shank, stitching is done over a regular machine needle. Position button and lower button foot. Place needle in the groove of the foot so the point enters the hole.

A larger shank results when the heavy end of the needle is utilized.

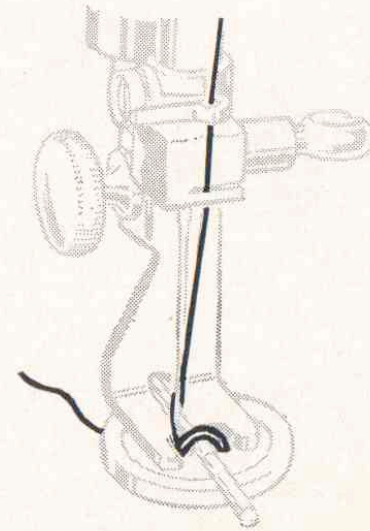

GENERAL PURPOSE FOOT

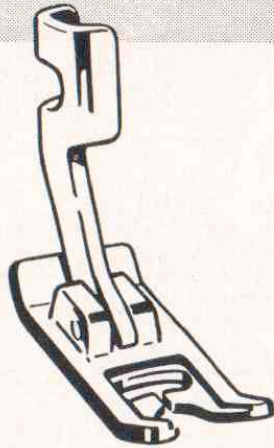

Used with the general purpose throat plate this foot provides a wide needle slot which accommodates all stitch settings and can be used for most sewing operations.

APPLICATIONS

Seams and Darts

Automatic Scalloping

Mending and Maintenance

Seam Finishes

SEAMS

LINGERIE SEAMS

Dainty lingerie seams are made durable and rip-proof with zigzag stitching (BL $2\frac{1}{2}$). After straight stitching the fitted seam on the wrong side, press both seam allowances in the same direction. From the right side, top stitch with a fine zigzag setting, letting the needle enter the seam line and then the seam thickness. Particularly good where flat bias seams are desired.

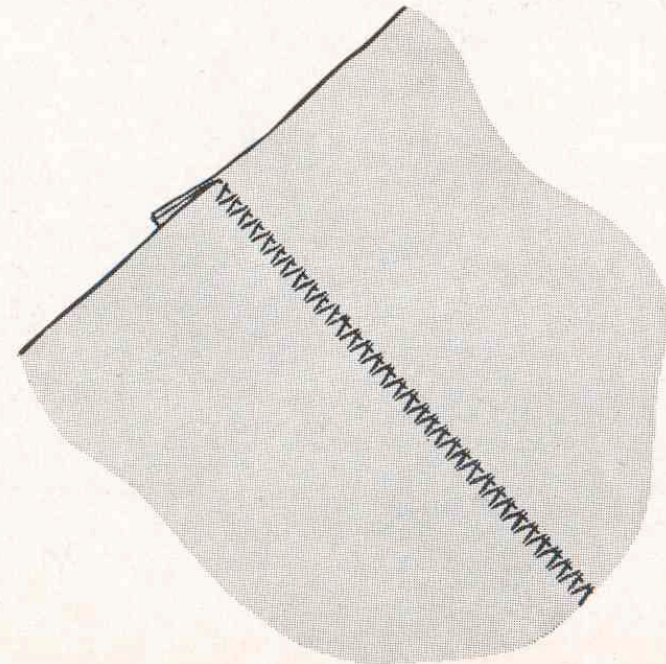

SEAMS

FLAT FELLED SEAMS

Zigzag stitching gives strength and durability to flat felled seams.

Form the seam to the right side of the fabric, taking full seam allowance, using a zigzag stitch (BL 3).

Press the seam open, then fold and press the two edges together, keeping the right side of the zigzag stitch uppermost.

Trim away half the under seam edge.

Fold the upper seam edge evenly over the trimmed seam, and top stitch.

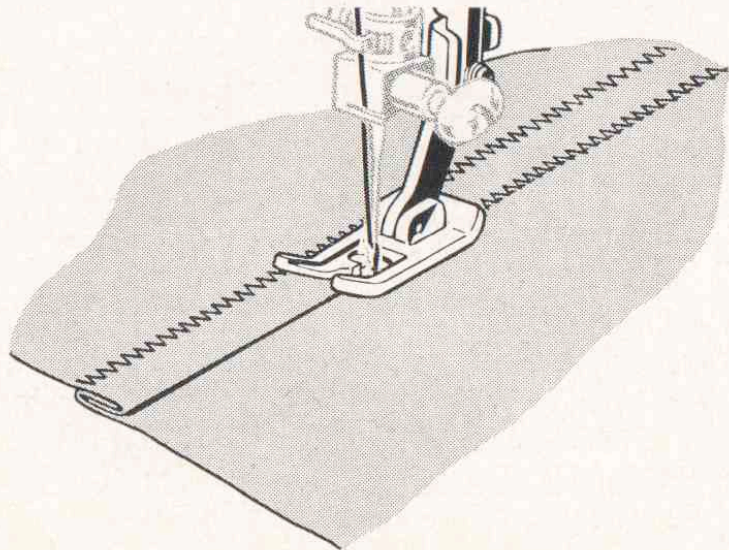

KNIT FABRIC SEAMS

A fine zigzag stitch (BL 1½) is ideal for seaming knit fabrics. Particularly desirable for underarm seams, or other seams where elasticity and give are needed.

For neckline and waistline seams, where a stay is needed to prevent undue stretching, this same stitch can be used to apply seam tape. To insure a flat, smooth finish, position the seam tape with the edge exactly on the seam line. If seam is curved, pre-shape tape to fit by steaming, and baste in place.

Stitch, allowing the needle alternately to enter the seam tape and seam line.

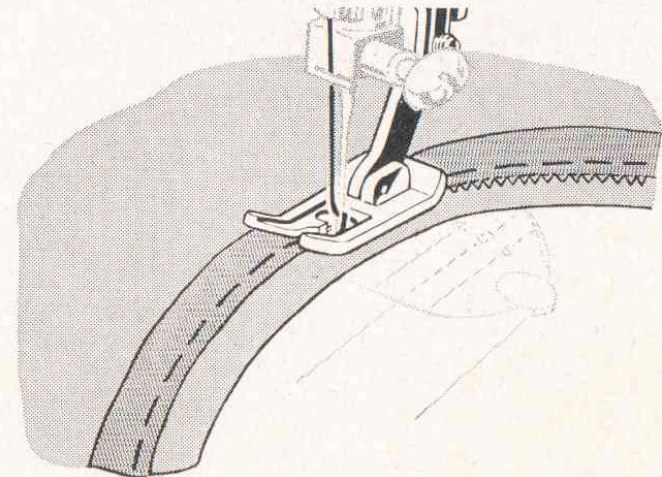

SEAM FINISHES

Seam edges support the garment and should be given a durable finish where fabrics have a tendency to ravel.

The zigzag stitch BL is ideal for such finishing. Place the stitching near the edge of the seam allowance, and then trim away excess fabric.

For an overedged seam, the blind stitch BO makes a durable bulkless finish. Good for straight grain, lengthwise seams.

Seam edges should be trimmed evenly, and the stitch then formed over the raw edge.

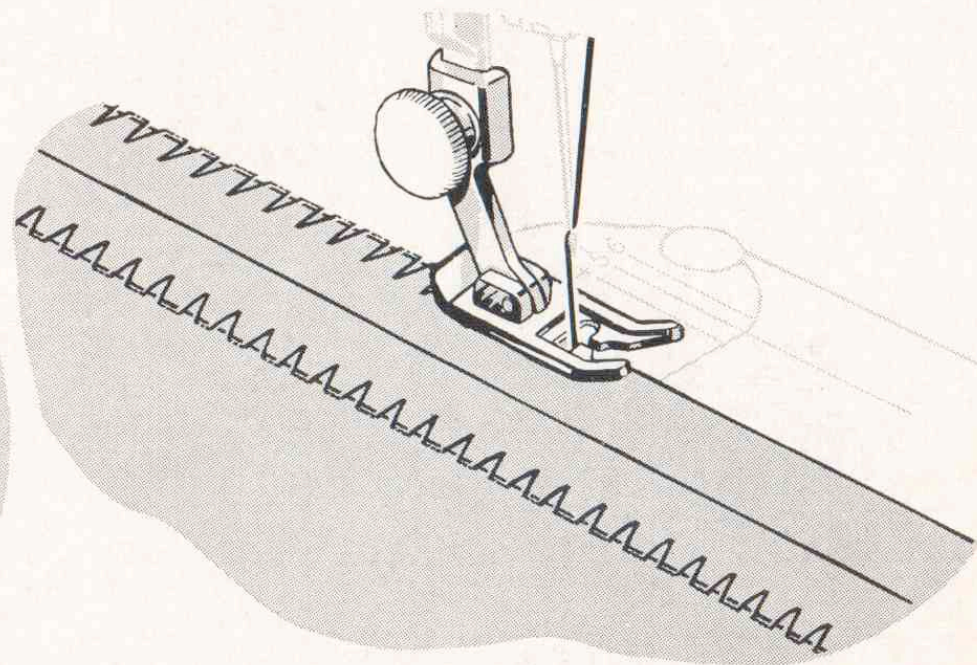
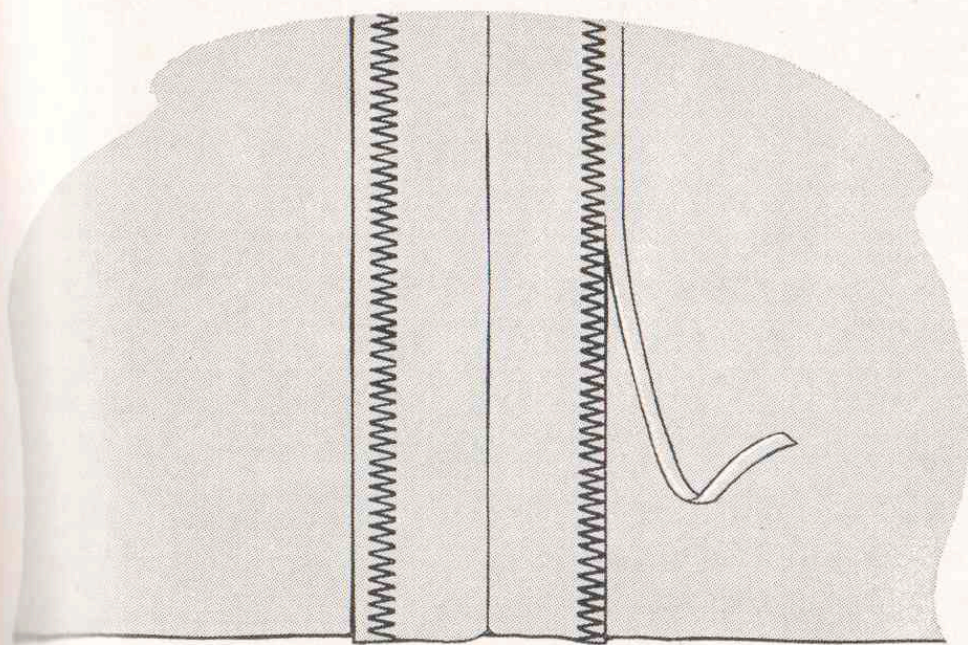

DARTS

Darts provide fit and contour in a garment and should be accurately stitched.

A straight stitch dart (AK 3) is usually formed by stitching from the seam edge, tapering gradually to the point, where the last 3 or 4 stitches parallel the fold. Stitch beyond the fabric to form a thread chain $\frac{1}{2}$ to $\frac{3}{4}$ inch in length. Tie the thread ends into a single knot close to the stitching.

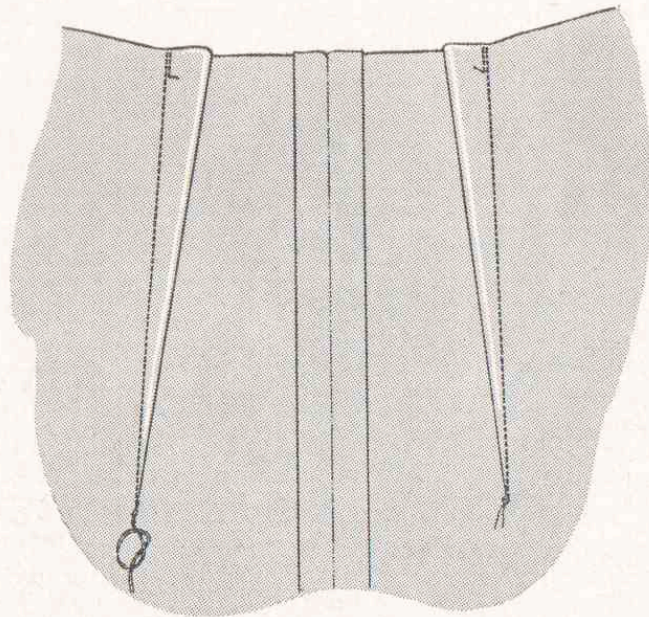

SINGLE THREAD DARTS

Darts add styling and interest when stitched with the fold to the outside of garment. Thread ends at the point of the dart are eliminated when the single thread principle is employed.

Unthread the needle. Use the thread leading off the bobbin and rethread the needle from back to front. Tie bobbin and upper threads together. Draw bobbin thread up through threading points, winding enough on the spool to complete a single dart. Lower the needle into the very edge of the fold at the point of the dart. Take any slack out of the thread by turning the spool. Lower the presser foot and stitch carefully toward the seam edge.

This method is also ideal for inside darts in sheer fabrics as thread ends are eliminated at the point of the dart.

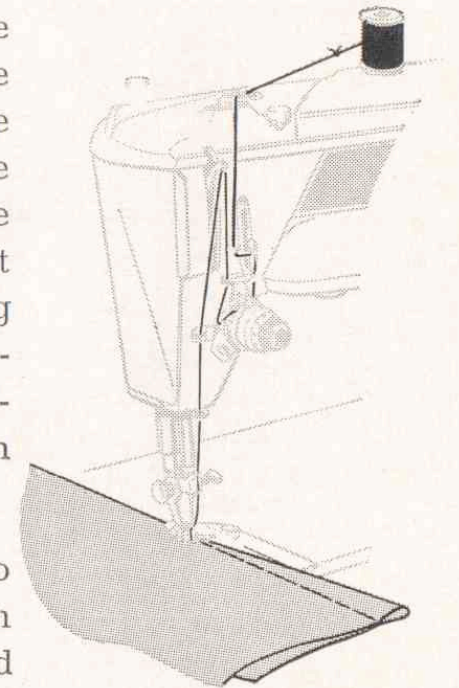

DARTS IN INTERFACING

Non-woven interfacings can be shaped without bulk with zigzag stitching. Selector setting BL or BQ may be used.

Cut out the dart allowance on the stitching line and bring the raw edges together. Pin, over a muslin stay, and stitch. Back stitch at both ends.

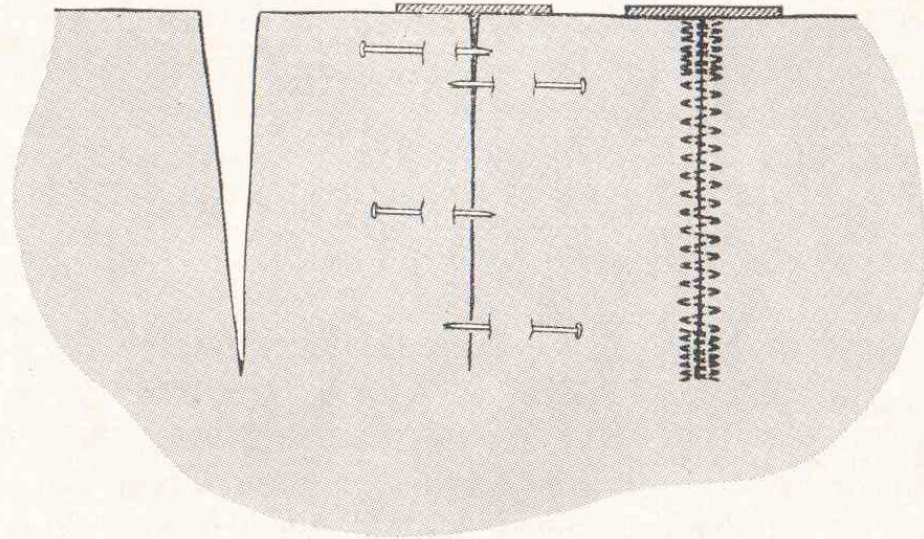

BLANKET BINDING

The multiple stitch zigzag (BQ) is an excellent stitch for applying blanket bindings and affords both a decorative and durable finish. Remove worn binding. Baste new binding securely in place and stitch. Adjust pressure if necessary, to accommodate the thickness of the blanket.

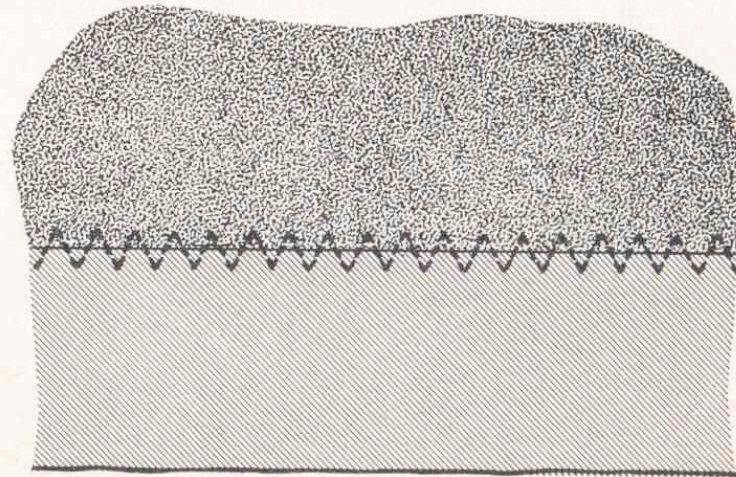

MENDING

Zigzag stitching is well suited for all types of household mending. Selector setting BQ provides a firm, flexible bond for the repair of rents and tears, and is ideal for the reinforcement and application of elastic. Stitch length and width are regulated according to need.

Rent or Tear. Trim away ragged edges. Place an underlay to the wrong side of the tear for reinforcement. Using the multiple stitch zigzag (BQ) follow the line of the tear bringing the edges together. Shorten the stitch length at ends and corners to give extra strength.

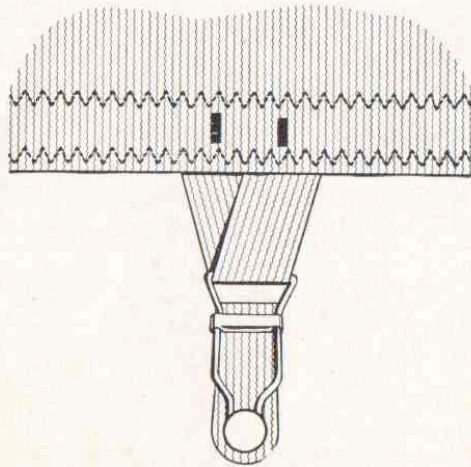

Application of Elastic.

Elastic, such as used in waist bands, must be stretched as it is applied, to insure fullness required in the garment.

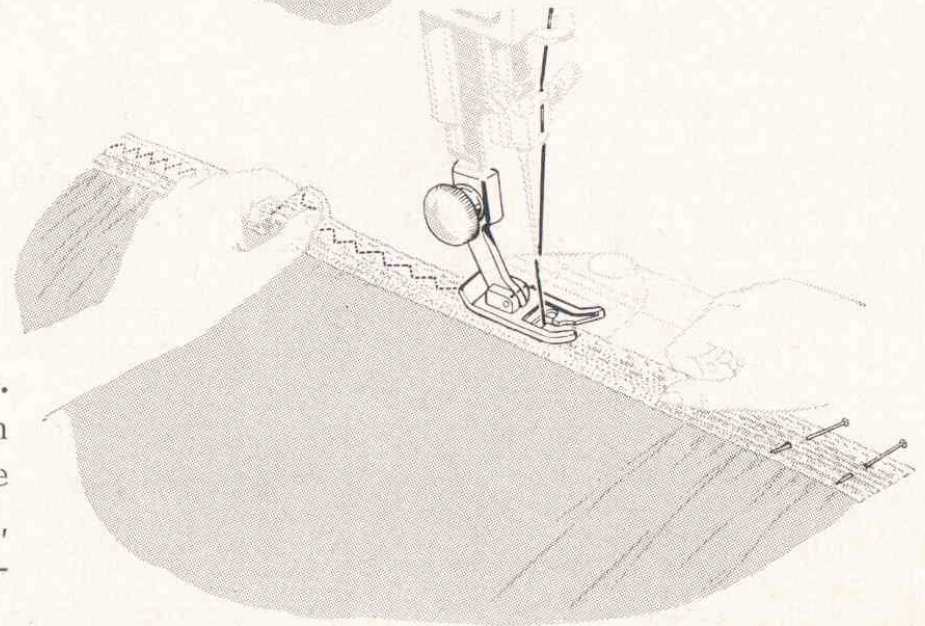
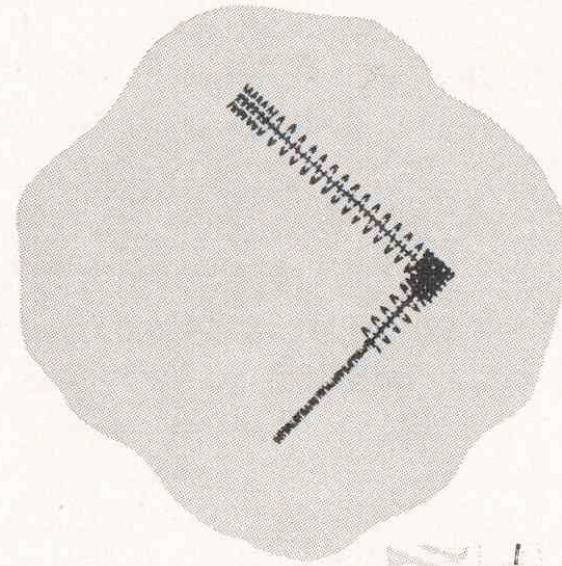

SCALLOPING

Dainty scalloped edges are used extensively as self trimming on blouses, dresses, lingerie and children's wear.

Perfectly formed and evenly spaced scallops are produced automatically at Selector Settings BR and BS ②.

BR results in a 12-stitch scallop.

BS ②, a 24-stitch scallop.

Stitch regulator and **Red Lever** settings vary the length and depth of the scallop.

After stitching, trim seam allowance to less than $\frac{1}{8}$ " and clip into the points between scallops.

Some fabrics may also need notching, for a smooth, evenly turned edge.

Turn, gently roll out scallops between the fingers and press.

When scalloping a shaped or bias edge it is best to use an interfacing.

When forming scalloped tucks, add an extra $\frac{1}{4}$ " to tuck allowance for seaming.

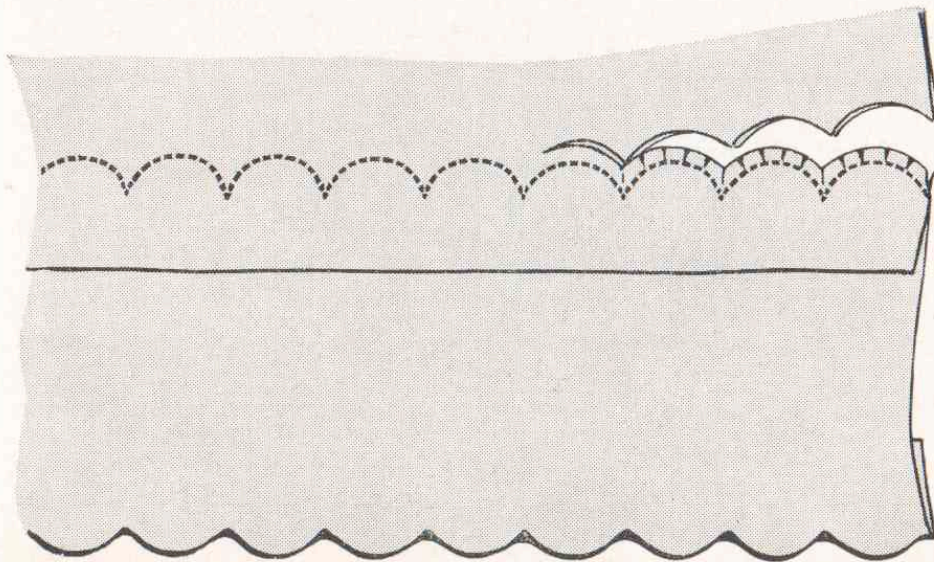

THE SEAM GUIDE

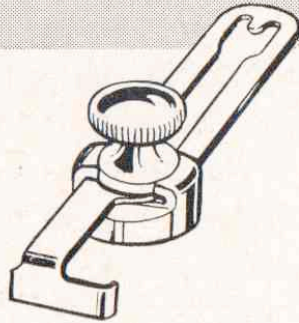

The seam guide aids in attaining uniformity of seam width. It provides for stitching to be spaced at any distance between $\frac{1}{8}$ " to $1\frac{1}{4}$ " from the edge of the fabric.

APPLICATIONS

Seams
Top Stitching

Blind Stitching
Decorative Stitching

The attachment is used in connection with a presser foot.

It is secured to the bed of the machine in either of the threaded holes to the right of the needle.

SEAMS

To guide seam stitching straight and parallel to the edge of the fabric, adjust the attachment for proper seam width. Align the guide with the presser foot. (Set Selector at AK, **Red Lever** at 3.)

Pin seam edges and baste if necessary. Hand basting can be eliminated on easy-to-handle fabrics. Place pins with the points toward the seam edge so they nip into the fabric at the stitching line. The hinged presser foot will ride freely over the points. Guide the fabric edges lightly against the guide while stitching.

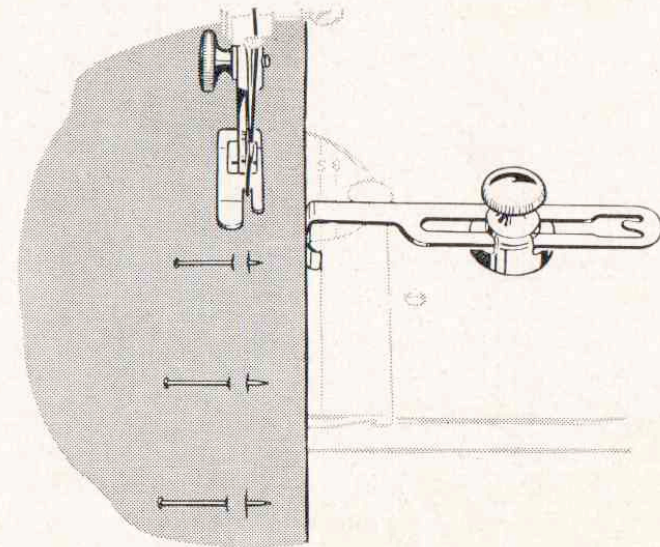

Curved seams require additional treatment in handling. A shorter stitch will provide greater elasticity and strength. Set the attachment at an angle so that the end closest to the needle acts as a guide.

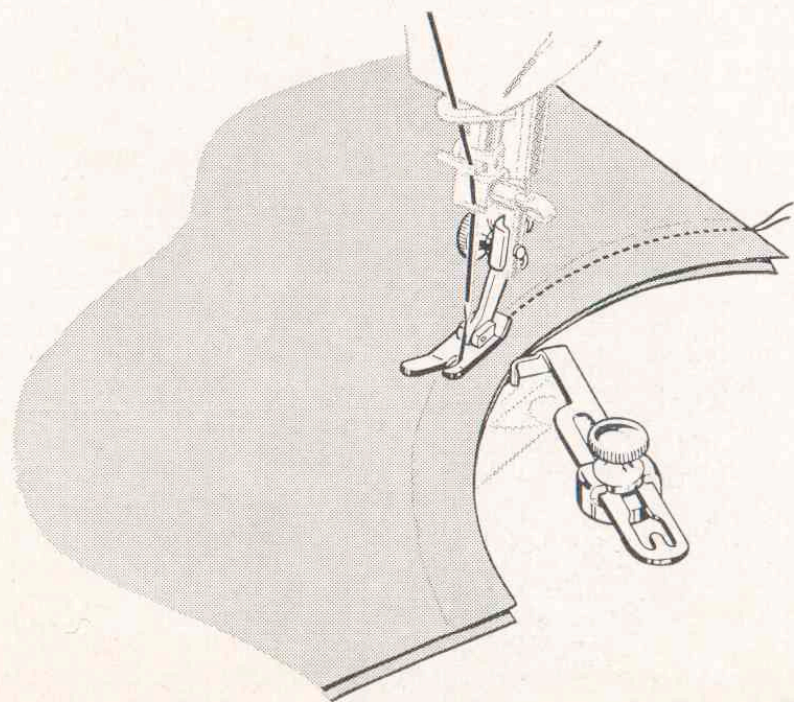

TOP STITCHING

A simple and practical way to accent the lines of a garment and at the same time give additional firmness.

Either single or multiple rows of stitching can be expertly placed along lapels and facing edges, around collars and pockets and as a hem finish.

A subtle effect may be achieved by using straight stitching, or a decorative touch may be added by using any of the attractive stitch patterns accomplished with this machine.

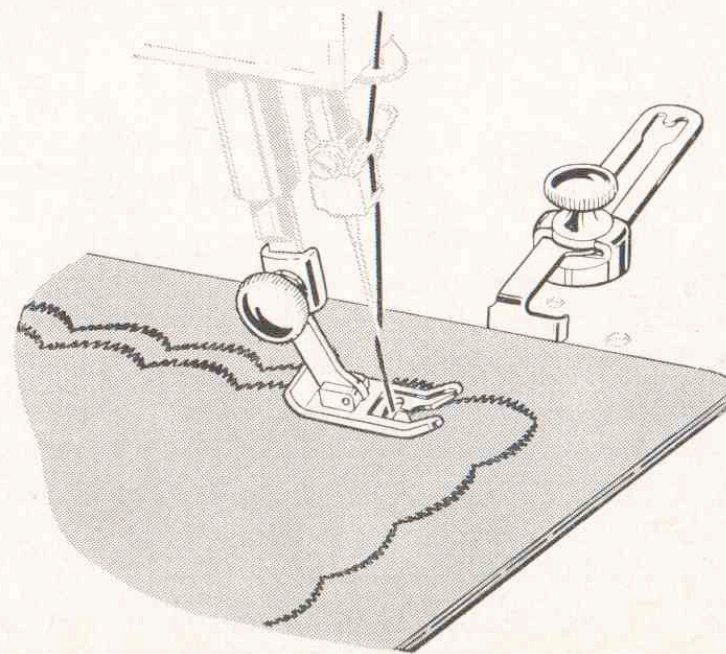

BLIND STITCHED HEMS

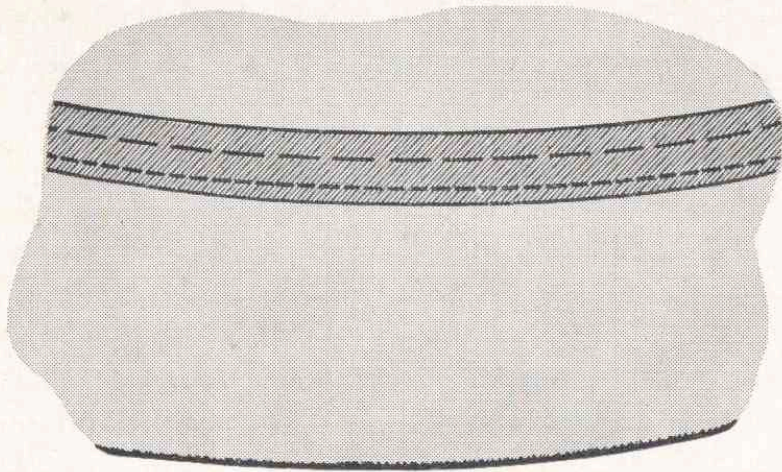

Selector: BO

Red Lever: 2-5

Stitch length: 10-20

Presser foot: General purpose

Throat plate: General purpose

Seam guide

Blind stitching provides a durable hem finish that is almost invisible, and comparable to hand sewing. It is equally suited to straight as well as

circular hems. Taped, bound, turned or unfinished hem edges can all be blind stitched with equal ease.

Mark, turn and press the hem in the usual way. Place a basting guide line approximately $\frac{1}{4}$ " from top hem edge.

Set Selector at BO. This setting produces four straight stitches, separated by a single sideward stitch to the left.

Red Lever setting for width of stitch is determined by the weight and texture of the fabric used.

Place the hem edge over the feed of the machine, turn back the bulk of the fabric to the line of basting, creating a soft fold.

Position the work so that the straight stitches are made on the hem edge and the sideward stitches pierce the fold.

The stitch length will regulate the distance between the blind stitches (10 to 20 stitches per inch).

Adjust the seam guide over the right toe of the foot until it rests next to the soft fold. While stitching, feed the fold against the flat of the guide.

A test sample in self fabric should be made to determine correct settings.

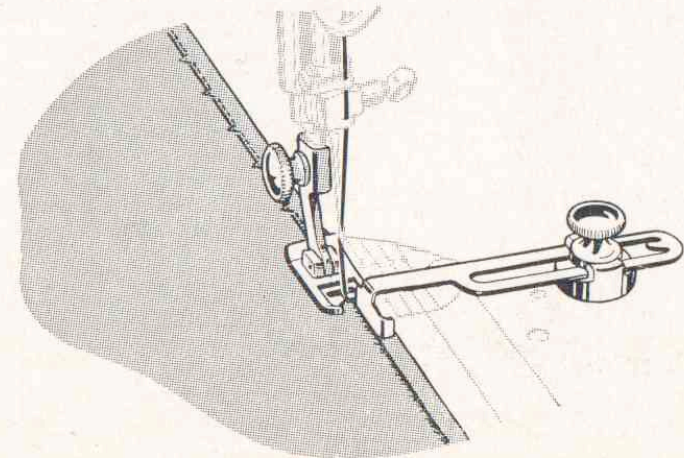

THE ZIPPER FOOT

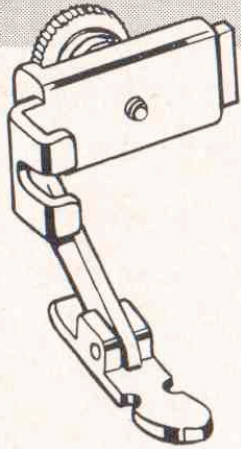

This foot is designed to facilitate the placement of stitching close to a raised edge. The hinged feature of this foot insures even feeding over pins, heavy layers of fabric or cross seams. It is attached to the machine in place of the regular presser foot, and may be adjusted to either the right or left side of the needle. Straight stitch or zigzag settings may be used.

APPLICATIONS

Zipper Insertions
Corded Seams

Tubular Cording
Slip Cover Welting

Preparation. Secure the zipper foot to the presser bar as you would the regular presser foot. Set Selector and **Red Lever**. Adjustment to the right or left of the needle is made by loosening the thumb

screw at the back. Check the position of the foot by lowering the needle into the side notch, making sure it clears the foot. Lock it into position by tightening the thumb screw.

ZIPPER INSERTION

Selector: AK

Red Lever: 3

Throat plate: General purpose

Zipper foot

Skirt Zipper. Machine baste the placket opening of the skirt and press this seam open. Attach the zipper foot to the machine and position it to the right of the needle. Open the zipper. Place the zipper face down on the seam allowance with the edge of the teeth at the seam line. Turn the back seam allowance away from the body of the skirt. Stitch the zipper tape to the seam allowance.

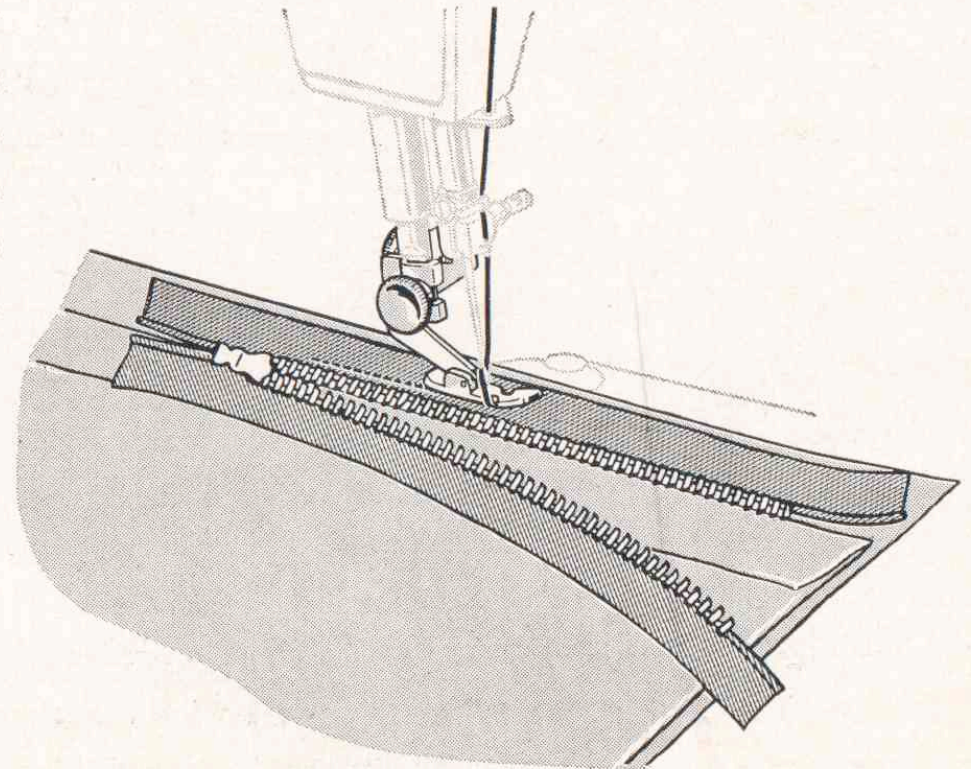

ZIPPER INSERTION

Move the foot to the left. Close the zipper and turn it face up. Smooth back the seam allowance at the edge of the zipper. Top stitch it to the tape close to the folded edge.

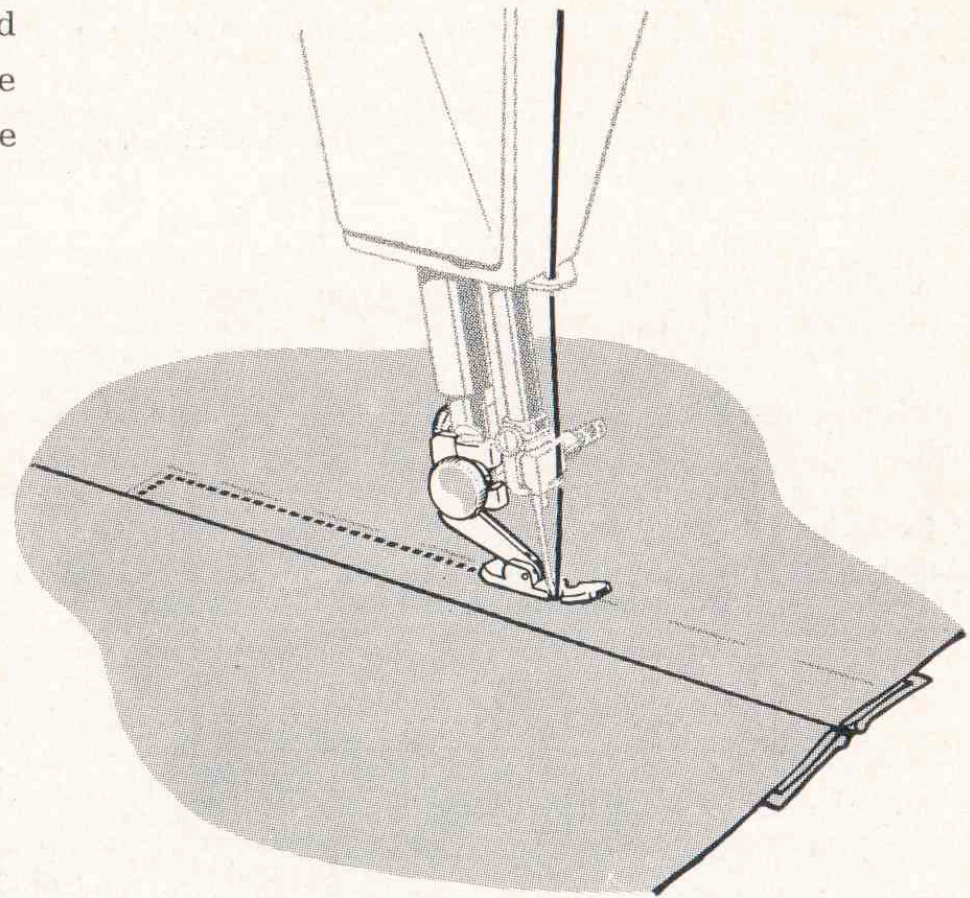
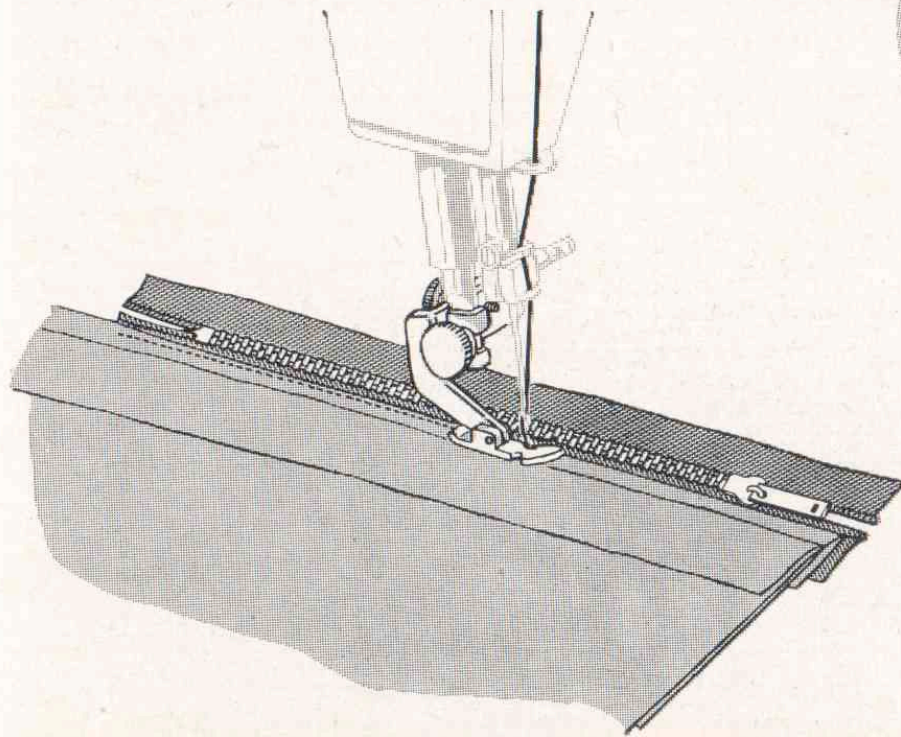

Turn zipper face down. Turn work to right side and pin in place. Baste. Move the foot to the right. Stitch across the lower end of the zipper and up to the waistline. Remove basting.

BLIND STITCHED ZIPPER INSERTION

Blind stitching the final step of a zipper insertion results in a fine finish that is almost invisible and comparable to hand sewing. Particularly suitable for chiffons, sheers, velvets and all delicate fabrics where top stitching would be too harsh.

Allow a $\frac{7}{8}$ " seam allowance. Start the insertion in the usual way, through steps 1 and 2 (**pages 66 and 67**) but omit final top stitching.

Work from the right side of the garment and pin the front of the zipper tape into position.

Roll the work over finger to ease fabric and pin through all thicknesses. Baste about $\frac{3}{8}$ " from seam line to provide guide for blind stitching. Remove pins.

Selector: BO

Red Lever: 2½ or 3

Throat plate: General purpose

Stitch length: 12

Zipper foot

Set stitch and adjust zipper foot to the right side of the needle.

Turn garment inside out. Place zipper tape over feed of machine and turn back the front section of garment to line of basting, creating a soft fold. Position work so that the straight line of stitching is made through front seam allowance and zipper tape, and the sideward stitch pierces a few threads of the fold. Lower presser bar and stitch slowly. Remove bastings. Press.

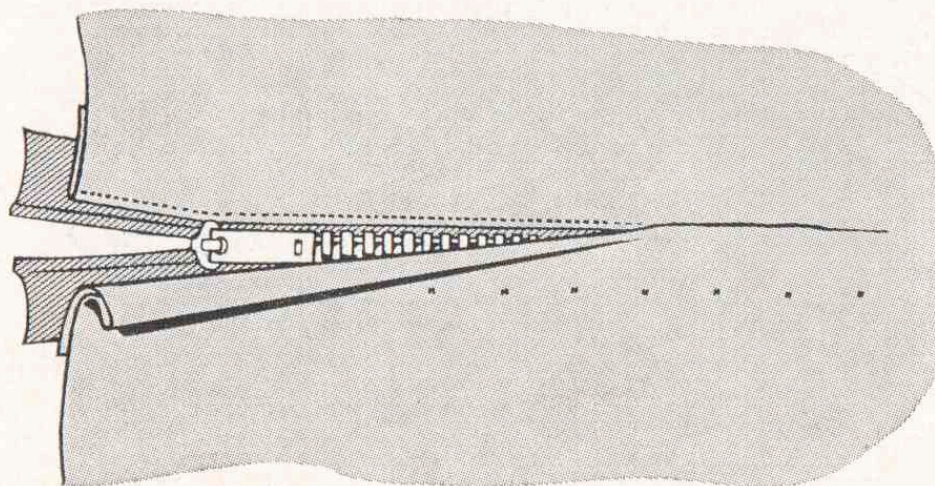
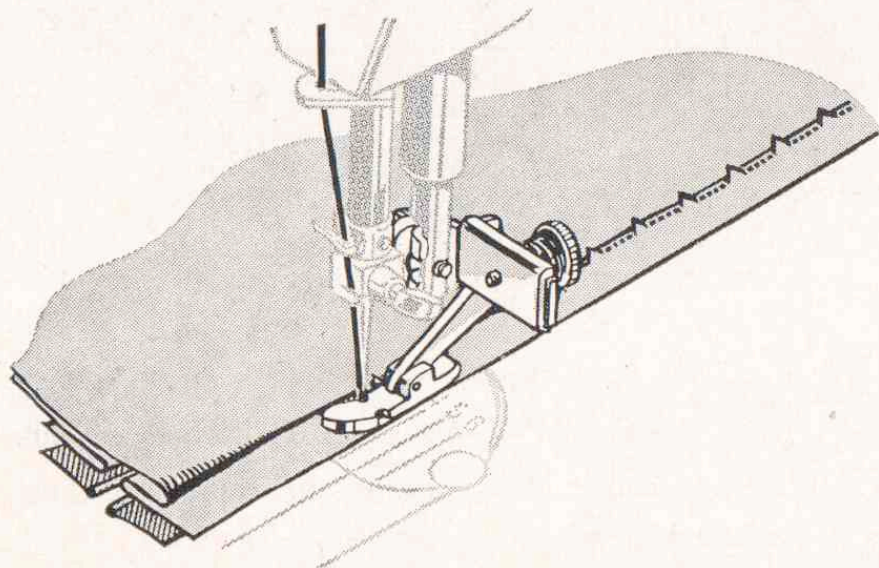

CORDED WELTING

Selector: AK

Red Lever: 3

**Throat plate: General purpose or
Straight stitch**

Zipper foot

Cable cord comes in a variety of sizes and when covered with a firmly woven fabric makes a corded welting that is an excellent seam finish.

This welting is prepared in advance and then stitched into the seam. Cut a true bias strip $1\frac{1}{4}$ inches wide, plus three times the width of the cord of either self or contrasting fabric. Sew strips together on the lengthwise grain to obtain desired length.

Set Selector. Adjust zipper foot to the left side of the needle. Encase the cord in the bias strip, raw edges even. Lower presser bar. Stitch close to the cord, using a stitch length slightly longer than for seaming the weight of fabric being used. Do not crowd the stitching against the cord.

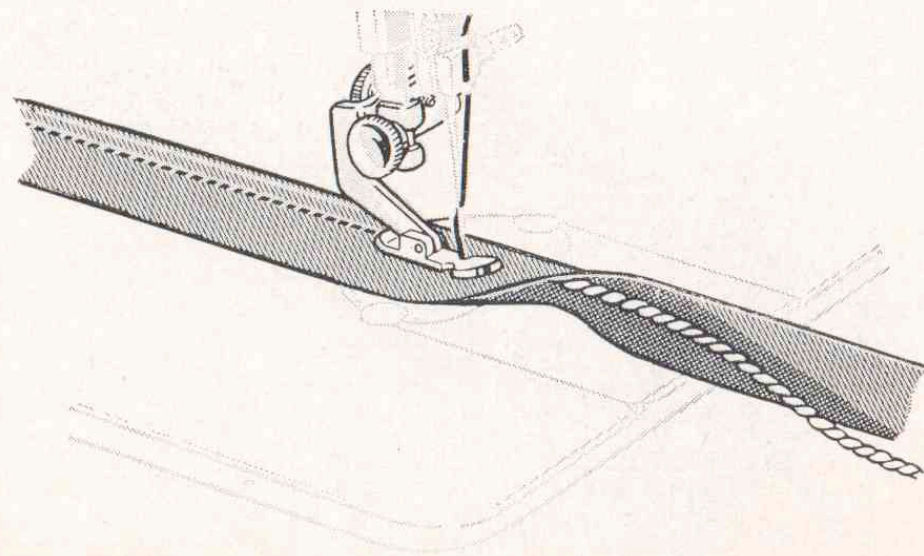
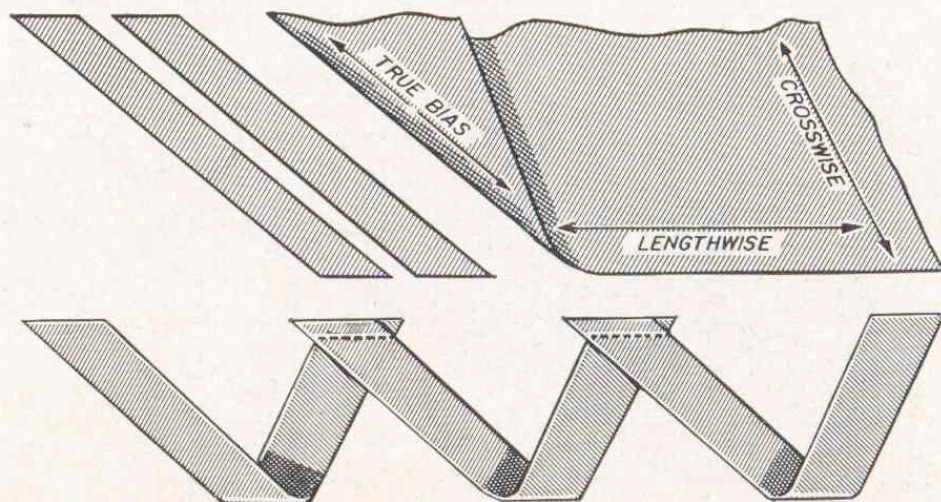

CORDED SEAMS

Selector: AK

Red Lever: 3

Throat plate: General purpose or
Straight stitch

Zipper foot

The corded seam is a typical treatment for slip covers, children's clothes, blouses and lingerie.

When cording a seam the zipper foot is usually adjusted to the right of the needle so that the bulk of the work will fall to the left.

Set Selector and **Red Lever**. Attach the corded welting to the right side of a single seam edge,

with the same stitch length used to make the welting (**page 69**). Guide the edge of the foot next to the cord, but do not crowd.

Place the attached corded welting over the second seam edge, and pin or baste together.

Keep the first stitching uppermost as a guide and position the seam under needle. Stitch, this time crowding the foot against the cord.

This method produces evenly joined seam edges and tightly set welting.

Curved seams are corded as easily as straight seams, except that a shorter stitch length is used. Since the seam allowance of the welting is bias, it is not difficult to shape it to the seam.

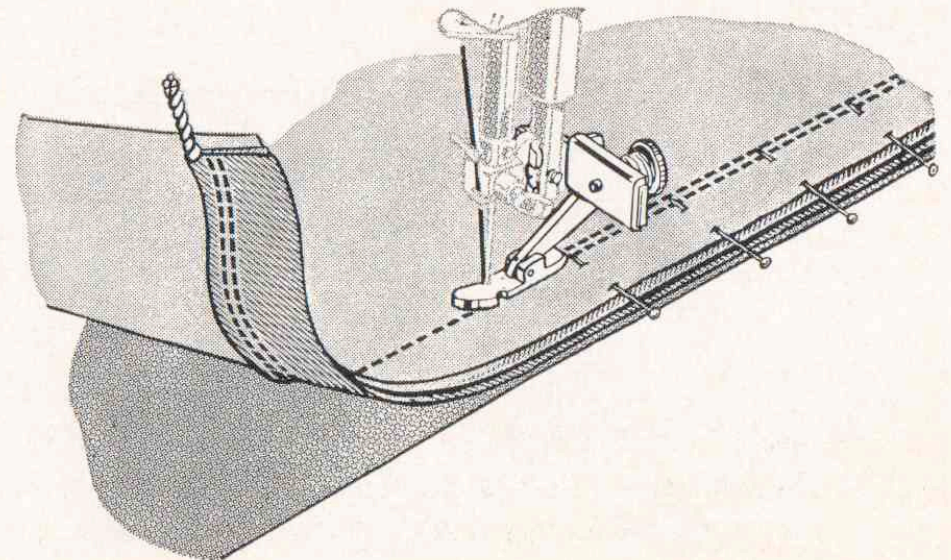
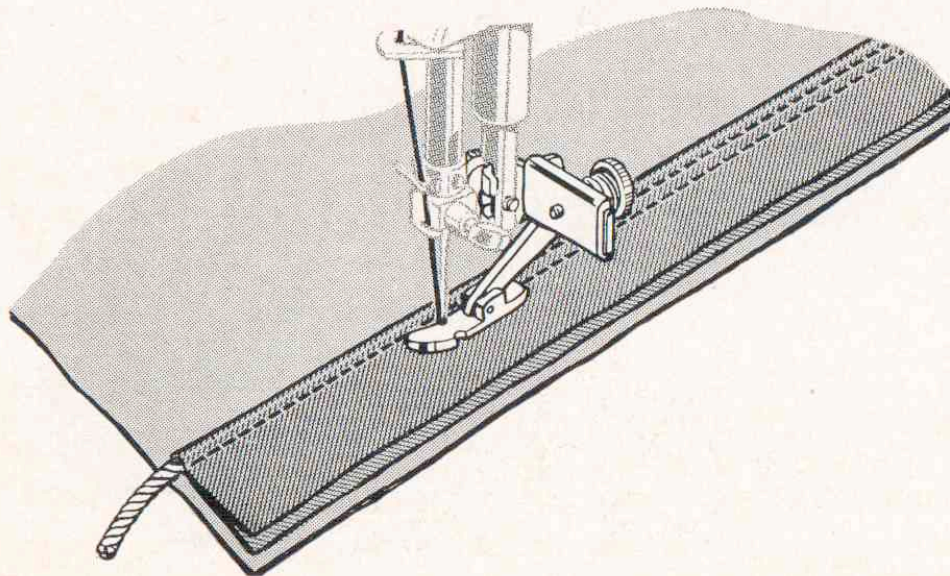

THE FOOT HEMMER



The narrow hemmer forms and stitches a perfectly turned hem without basting or pressing. It is attached to the machine in place of the regular presser foot.

APPLICATIONS

Fine hems
Edging ruffles
Sheer seams

Hemming with lace
Lace insertion
Lingerie finishes

Selector: AK

Red Lever: 3

Throat plate: General purpose

Foot Hemmer

HEMMING

Set Selector and **Red Lever**. At the very edge of the fabric form a double $\frac{1}{8}$ " fold. Crease this fold for about 2". Draw the bobbin and needle threads

under the hemmer. Place the fabric under the foot and stitch through the creased fold for several stitches. Hold the thread ends in the left hand and guide the raw edge in front of the hemmer evenly into the scroll. Sew slowly, still holding thread ends until the hem is well started.

Soft fabrics will enter the scroll best with the foot down; firm, crisp materials with the foot raised.

Even feeding is essential to good hemming. The same width of fabric must be kept in the scroll of the hemmer at all times. A little practice will result in perfectly formed hems.

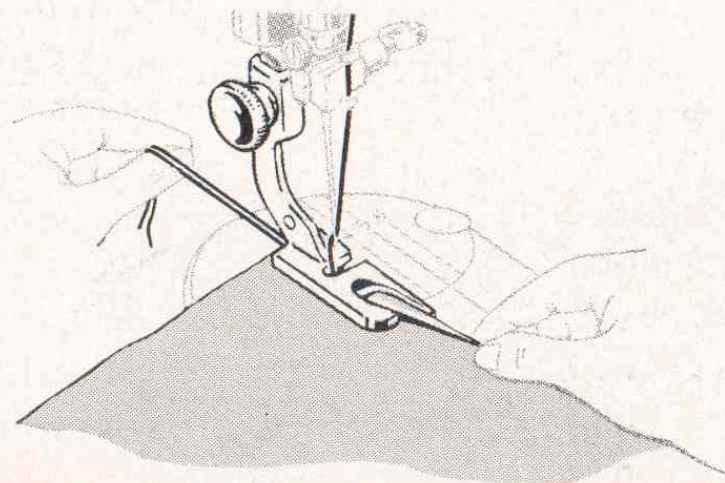

HEMMING WITH LACE

Selector: BL

Red Lever: 3

Throat plate: General purpose

Foot Hemmer

Most of the popular kinds of lace edging and insertion can be applied with the Foot Hemmer. It is an excellent way to trim children's clothes and to finish lingerie hems.

Lace Applied Over Hem. Fold and start the hem in the usual way. Starting about 1" down from the end of the lace, place the selvage under the needle and lower needle to hold lace firmly. Raise the foot slightly and slip the lace under the back portion of the foot, without disturbing the position of the fabric. Stitch slowly, guiding the fabric with the right hand, the lace with the left. Take care not to stretch the lace.

Lace Applied Under Hem. When using lace underneath the fold of a hem, the procedure is the same as when making a hemmed seam. Slip the lace in from the left as you would the second piece of fabric. This method is used where a neat finish is desired on both sides of the material.

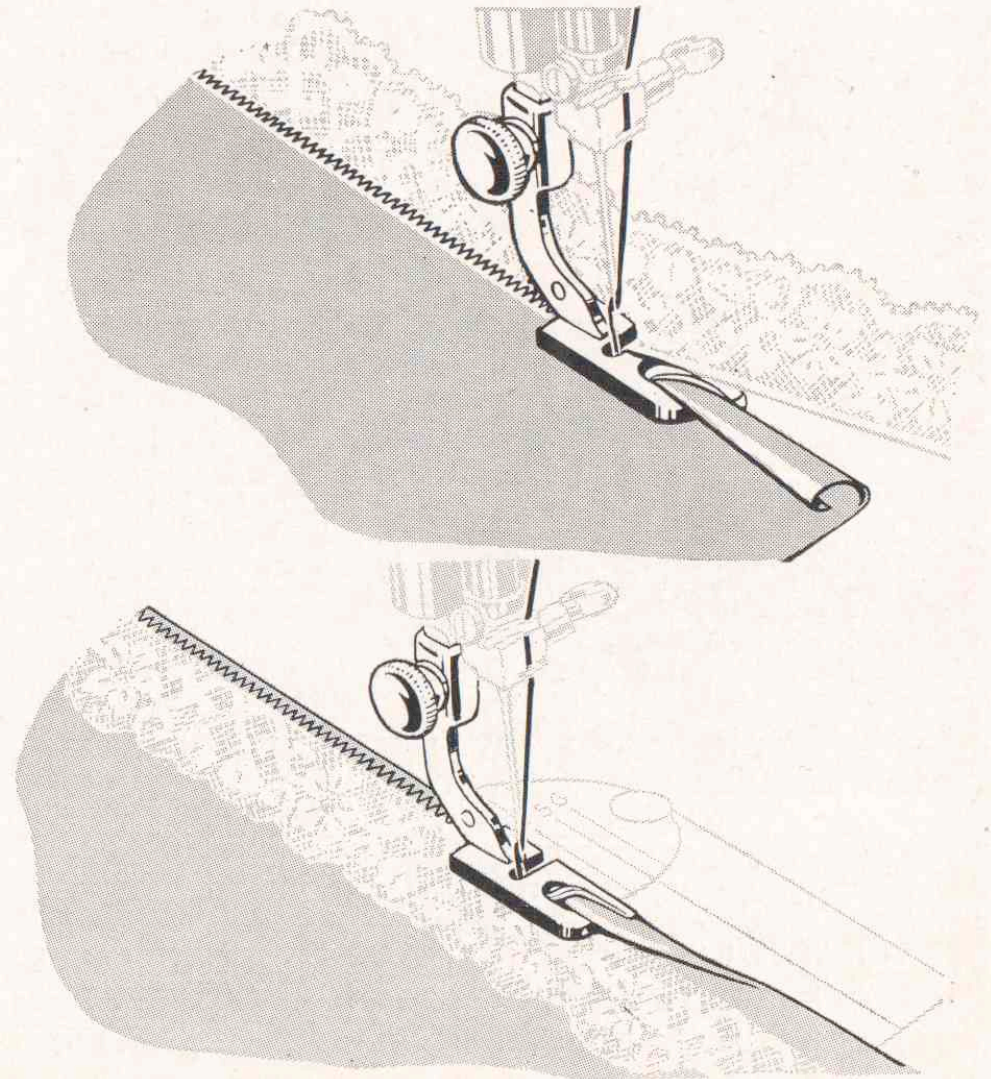

DECORATIVE HEMS

Selector: All settings

Throat plate: General purpose

Red Lever: 2 thru 5

Foot Hemmer

Narrow hem edges can be turned and decorated in one operation using the foot hemmer and a stitch pattern.

This time-saving finish is especially suited to ruffle edges and aprons.

Lingerie and most delicate fabrics can be attractively finished with a soft shell edge. This effect is obtained by hemming with Selector set at BO or BQ and **Red Lever** at 4.

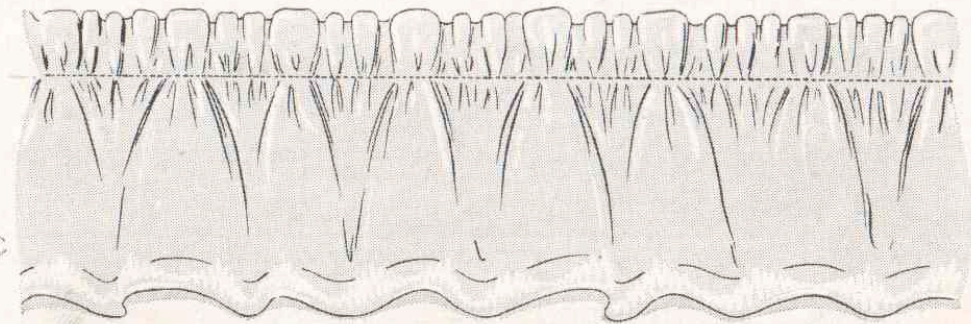
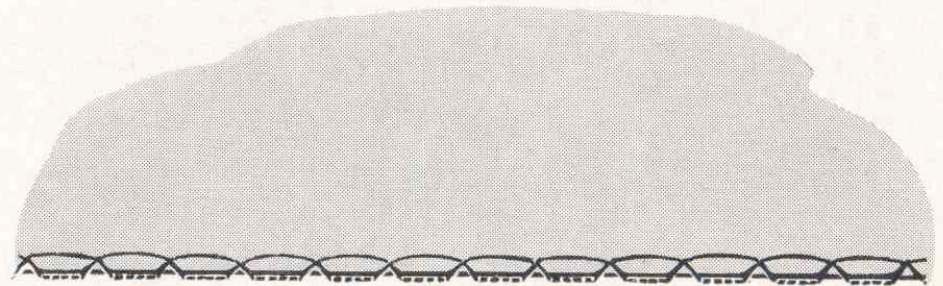
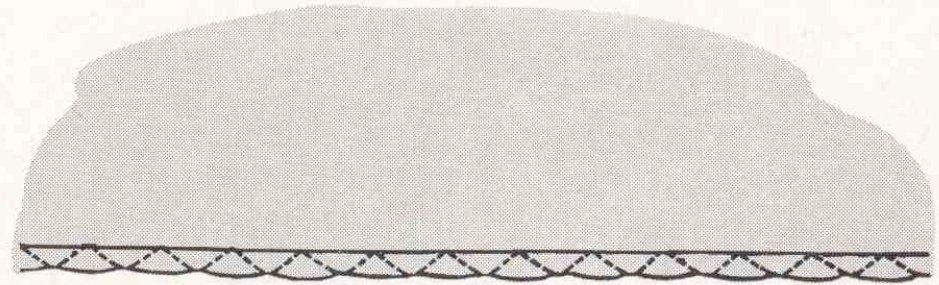
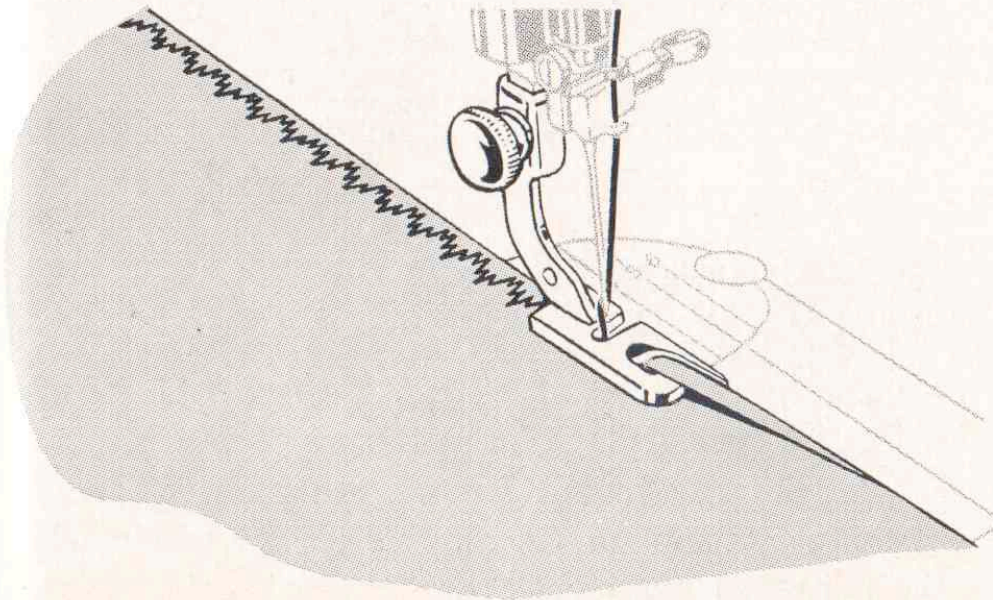

MULTI-SLOTTED BINDER

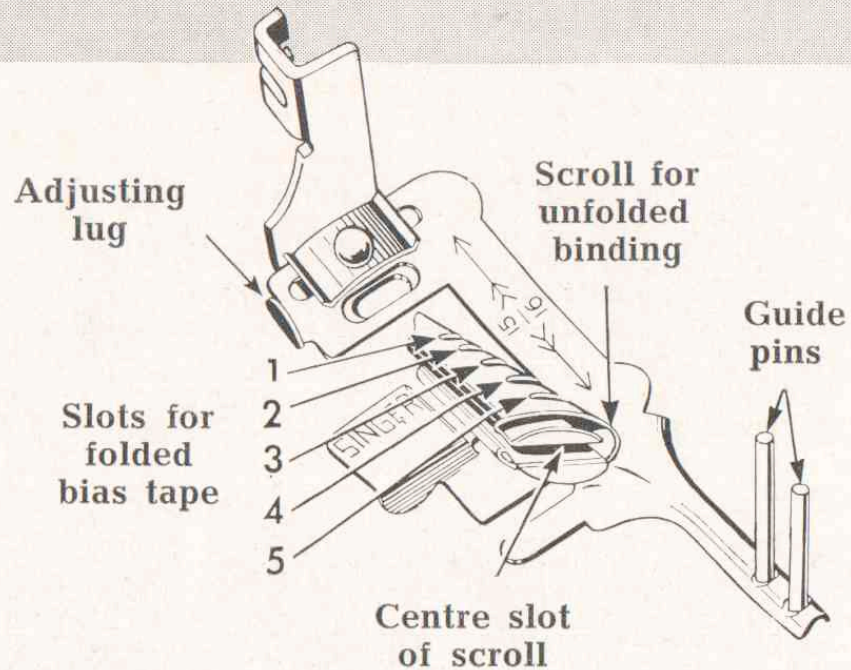

The multi-slotted binder is used to apply commercial binding as well as self fabric bias to an unfinished edge.

This colourful trim is attractive when applied to children's wear, aprons and fabric furnishings. It is a practical finish for seam edges that ravel and for making bound seams.

The attachment will accommodate both straight and zigzag stitching.

Selector: All settings
Red Lever: 2 thru 5
Throat plate: General purpose
Multi-slotted binder

Cut binding diagonally to form a long point. Commercial binding in sizes 1 to 5 is inserted from the right into the appropriate slot in the scroll. Unfolded bias $\frac{15}{16}$ of an inch wide is inserted into the opening at the end of the scroll.

Pull binding through scroll until the evenly folded edges are under the needle. The free length of the binding is held between the guide pins.

Set Selector and **Red Lever** for either straight or zigzag stitching.

Insert the edge to be bound into the centre of the scroll. The stitching is positioned close to the edge of the binding by moving the scroll portion of the attachment to the right or left by means of the adjusting lug.

MULTI-SLOTTED BINDER

Lower the presser bar. Allow the attachment to do the work, merely guiding the fabric into the centre of the scroll as you stitch.

Curved edges require slightly different fabric handling than straight edges.

Inside curves are straightened as they are fed into the binder. If the fabric is soft and has a tendency to stretch, reinforce the edge with a single row of stitching before binding.

Outside curves tend to lead away from the centre slot of the scroll and should be guided so that a full seam width is taken at the needle point. Do not attempt to pull or straighten fabric into the full length of the scroll.

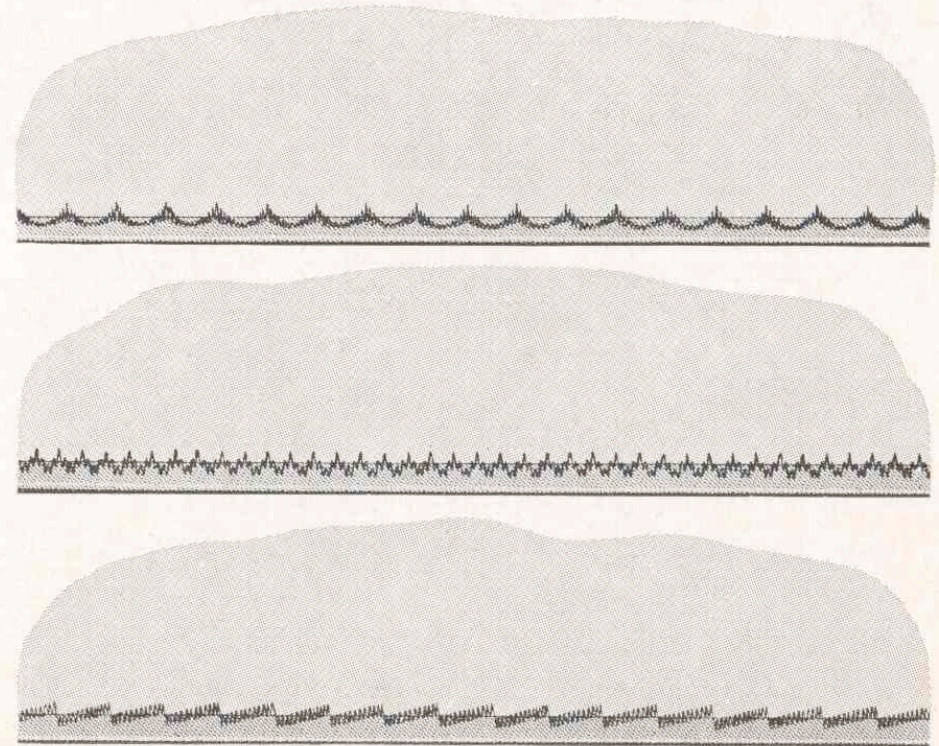
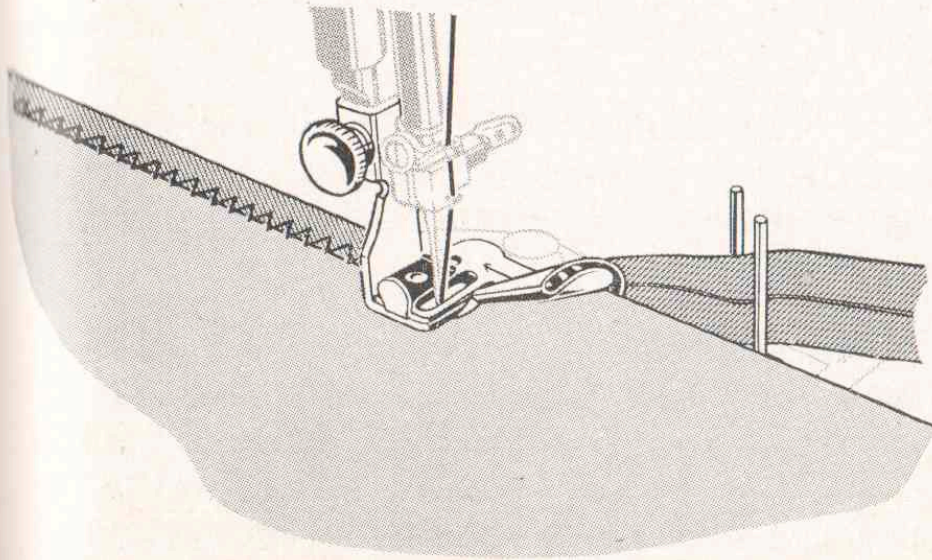

THE RUFFLER

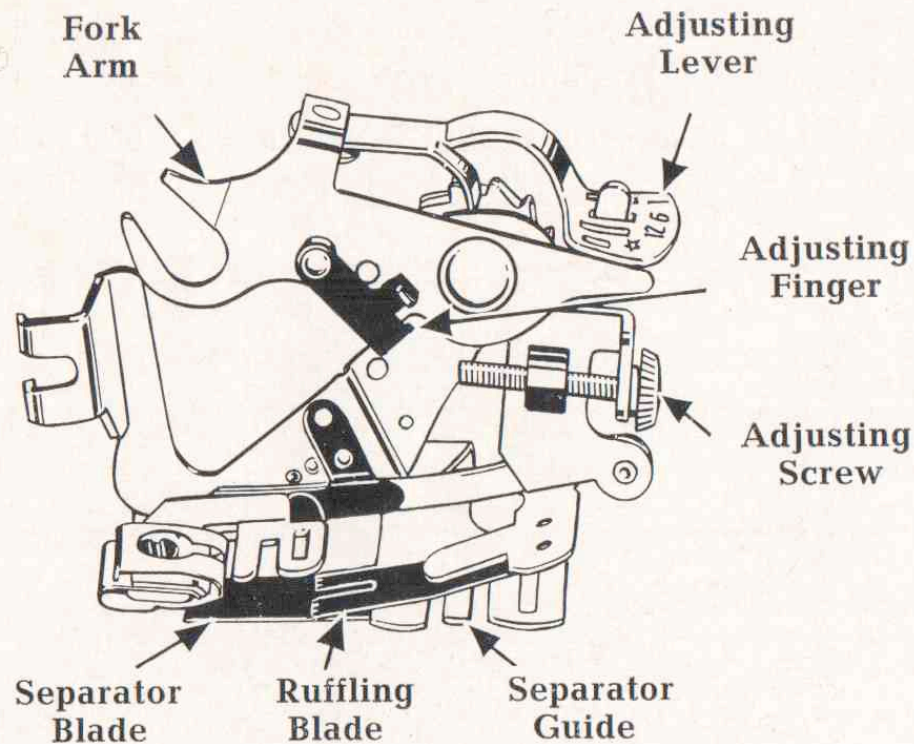

This attachment offers a simple and effective way to make gathered and pleated ruffles. Ruffles may be made separately or made and applied at the same time. The ruffler is attached to the machine in place of the regular presser foot and is used with a straight stitch setting only.

Selector: AK

Red Lever: 3

Throat plate: Straight stitch
Ruffler

Adjusting Points. 1. The adjusting lever sets the ruffler for gathers or pleats. The Number 1 space setting is for gathers, and places fullness at every stitch. Numbers 6 and 12 are space settings for pleats, spacing them either 6 or 12 stitches apart. The star is for straight stitching, and is used when grouping gathers or pleats.

2. The adjusting finger is used only for pleating and affects the width of the pleat. It is thrown out of action by bringing it out of contact with the adjusting screw.

3. The adjusting screw regulates the fullness of gathers or pleats. When turned in to its limit with the adjusting finger in place, the attachment is set for its deepest pleat. When turned outward to its limit and the adjusting finger out of action, the ruffler gives only a hint of fullness.

THE RUFFLER

Activating Parts. The ruffling blade and the separator blade are of blue steel and hold the material to be gathered between them. The ruffling blade forms the gathers or pleats by carrying the fabric to the needle according to the spacing and fullness to which the ruffler is adjusted. The separator guide is slotted to guide seam edges evenly and to separate the ruffle strip from the material to which the ruffle is attached.

Preparation. Raise the needle to its highest point.

Locate the attachment on the machine in place of the regular presser foot, at the same time fit the fork arm over the needle clamp screw. Make sure both the presser bar screw and the needle clamp screw are tightened securely.

Gathering. Set the adjusting lever of the attachment on Number 1 setting, and throw the adjusting finger out of action. Turn the adjusting screw for the amount of fullness desired and set the stitch length to space the fullness. The attachment is adjusted for maximum fullness by turning the adjusting screw all the way in; for less fullness turn it outward.

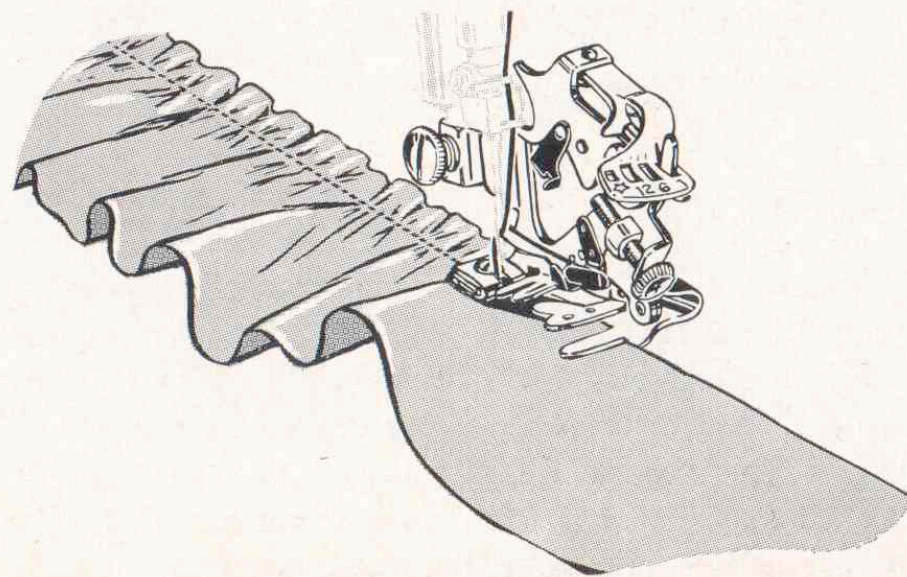

THE RUFFLER

The length of the sewing machine stitch also affects ruffle fullness. Since a given attachment setting puts an equal amount of fullness into each stitch regardless of its length, shortening the stitch (more stitches to the inch) makes the ruffle more full, lengthening the stitch (few stitches to the inch) makes it less full. For fine, closely spaced gathering use a short stitch and an outward adjustment of the adjusting screw. For deeper, less closely spaced gathering, turn the adjusting screw inward and use a medium length stitch.

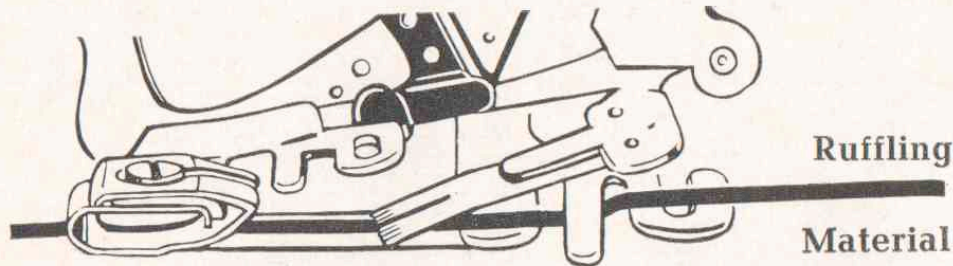

Insert the material to be gathered between the blue blades and through the first separator guide. Draw to the back of the needle. Lower the presser bar and stitch. The texture of the fabric influences the performance of the ruffler as well as the results. Soft fabrics, cut on the crosswise grain, are best adapted for gathered ruffles. Always test stitch length and ruffler setting on a scrap of self fabric before proceeding with the actual work.

Attaching Ruffle. To form and attach a ruffle in one operation, place the ruffle strip between the two blue blades and through the first separator guide, and the material to which it is to be attached

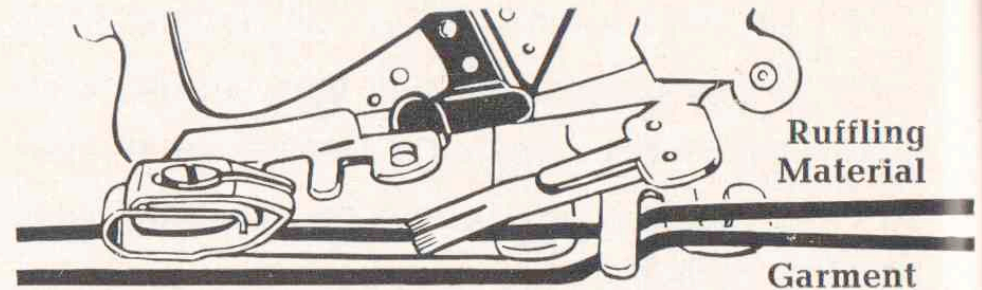

between the separator blade and the feed of the machine. Proceed as for plain gathering. Right sides of the fabric are placed together when the seam is to fall to the inside.

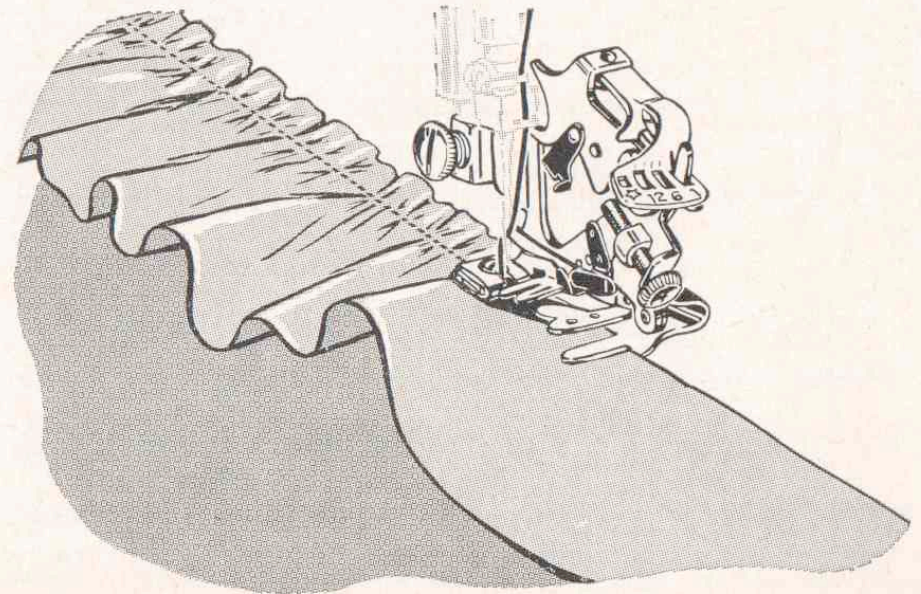

THE RUFFLER

Pleating. Move the adjusting lever of the ruffler to the space setting desired for pleats either 6 or 12 stitches apart.

For the deepest pleat, activate the adjusting finger and turn the adjusting screw inward to its maximum setting. For smaller pleats turn the adjusting screw outward.

Set stitch length. A short stitch places the pleats more closely together; a long stitch separates the pleats for a greater distance.

Insert the fabric to be pleated between the blue blades and into the first separator guide. Lower presser bar and stitch.

Crisp fabrics cut on the crosswise grain form the sharpest pleats. Glazed fabrics handle best if the glazed side is downward and the soft backing is next to the ruffler blade.

Group Pleating. By using the star setting (straight stitching) alternately with the 6 or 12 stitch setting, pleats are formed in groups. Even spacing between groups is accomplished by counting the number of stitches.

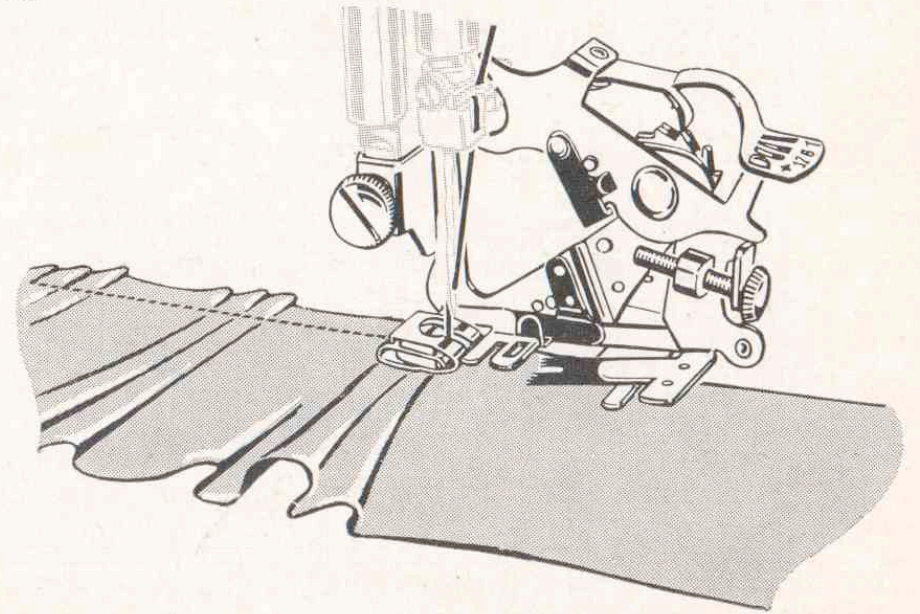
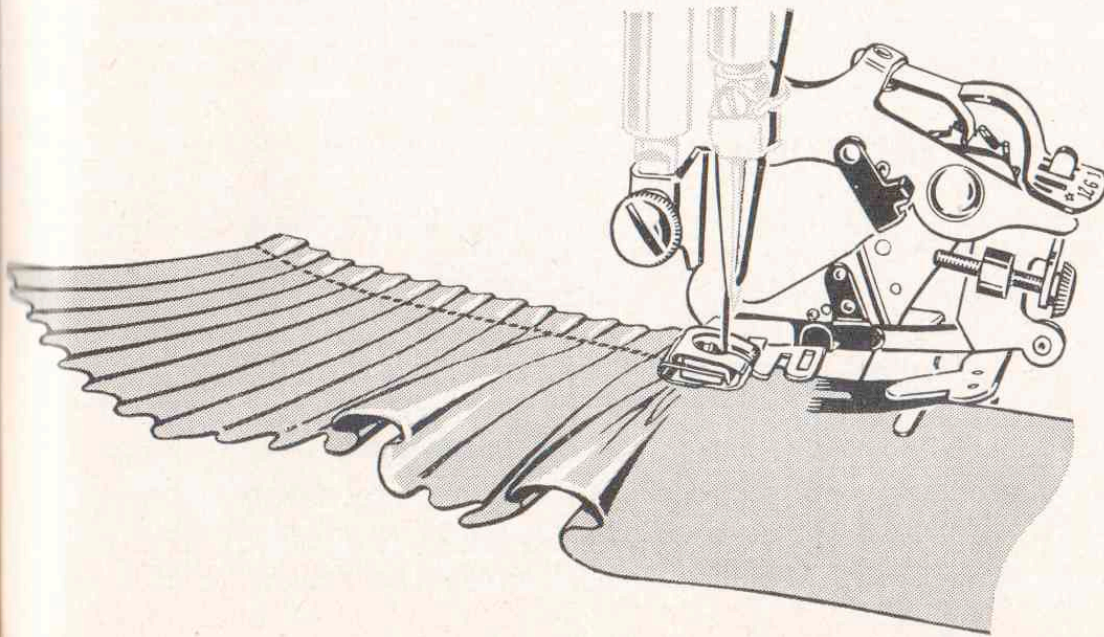

DARNING

Selector: AK

Red Lever: 3

Throat plate: Straight stitch (Raised)
With embroidery hoop guide

Presser foot: None

Stitch length: Finest

Household linens, children's clothes and knit wear of all kinds can be repaired with the darning stitch.

Trim away ragged edges from area to be darned. Centre worn section in embroidery hoops.

Attaching Embroidery Hoop Guide —

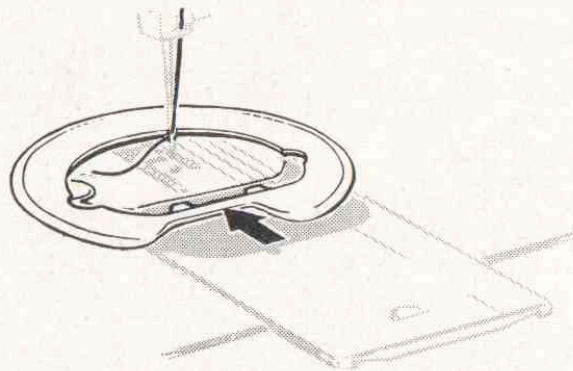

Raise throat plate and open slide plate. Position hoop guide over throat plate as shown. Slide hoop guide into place and close slide plate.

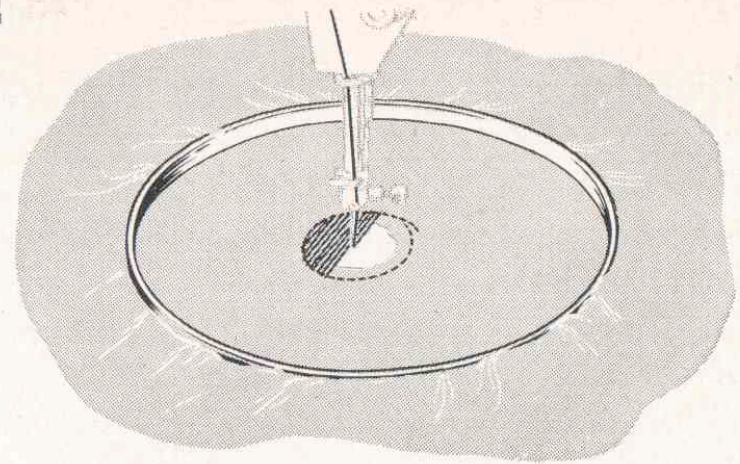

Position work under needle and lower presser bar. Hold needle thread loosely with left hand, turn hand wheel over and draw bobbin thread up through fabric with loop of needle thread. Hold both thread ends and lower needle into fabric.

Outline opening with running stitches $\frac{1}{4}$ " from edge for reinforcement.

Stitch across opening, moving hoops under needle at a slight angle, from lower left to upper right. Keep lines of stitching closely and evenly spaced.

Run machine at a moderate speed and control hoops with a steady movement. Slow movement of hoops produces a short stitch; more rapid movement lengthens the stitch. Longer stitches are best for knit and tricot fabrics as they are softer and more flexible when garment is worn. Short stitches are best for cottons and linens as they approximate weave of fabric and will withstand many launderings.

FREE MOTION WORK

Selector: BL

Red Lever: 2—5

Throat plate: General purpose (Raised)
With embroidery hoop guide

Presser foot: None

Stitch length: Finest

Script monograms, satin stitched scallops and embroidery can be effectively accomplished with the zigzag stitch when the free motion principle is employed.

Trace or mark the design on the right side of the fabric. Place the work in embroidery hoops, keeping the fabric taut.

Remove the presser foot and raise the throat plate. Set Selector at BL and **Red Lever** at desired setting.

Position the work under the needle and lower the presser bar to activate the tension. Bring the bobbin thread up through the fabric. Hold both thread ends and start stitching after positioning needle in fabric.

Move the hoops slowly following the outline of the design. Maintain an even rate of speed so that the stitches are uniformly placed. Shading the stitches from wide to narrow is controlled by the angle at which the work is placed and moved under the needle.

When scalloping is used as an edge finish, allow sufficient margin of fabric beyond the desired edge to fit the hoop. To maintain parallel stitches, scallops are followed without turning, the work remaining in line with the feed at all times. The points of the scallops are formed by lightly moving the work to the right or left, automatically producing the effect of a narrower stitch.

Some fabrics may require the addition of an underlay of crisp muslin or organdy. The darning and embroidery foot (available separately) will also contribute to the smooth handling of difficult materials as it provides a close control of both stitch and fabric.

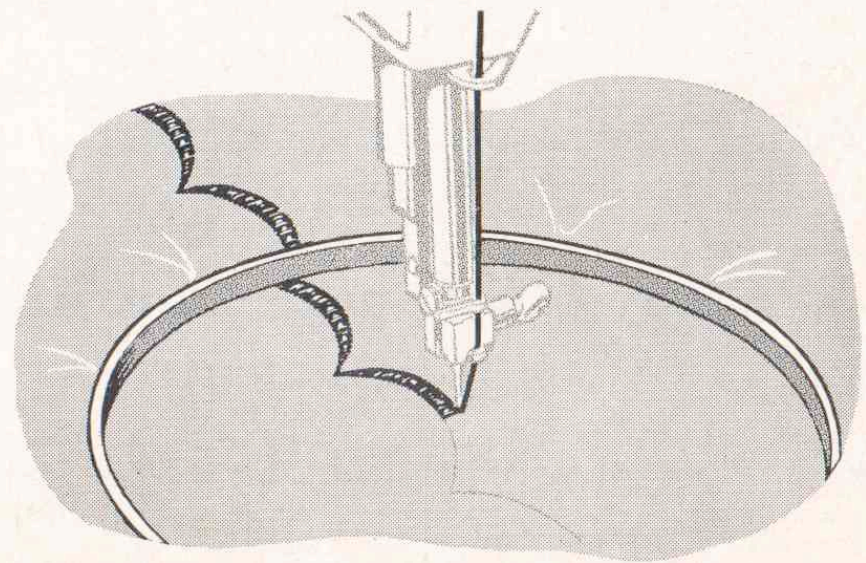

DECORATIVE STITCH PATTERNS

Examples of Stitch Patterns and their Selector Settings



DP 4



DS ② 2



DS ② 3



EP 2



FO 2



FR 2



FS ① 3

DECORATIVE STITCH PATTERNS

Examples of Stitch Patterns and their Selector Settings



GM 4



GP 4

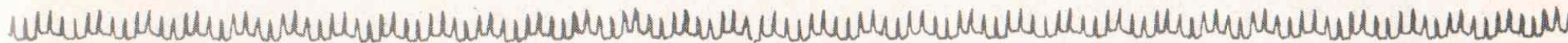

GS ② 2



GS ③ 4



HS ③ 4

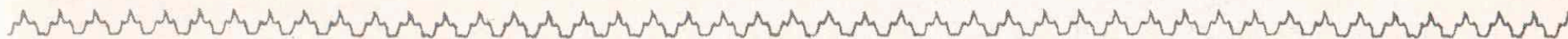

IL 2



IS ① 4

TO CLEAN THE MACHINE

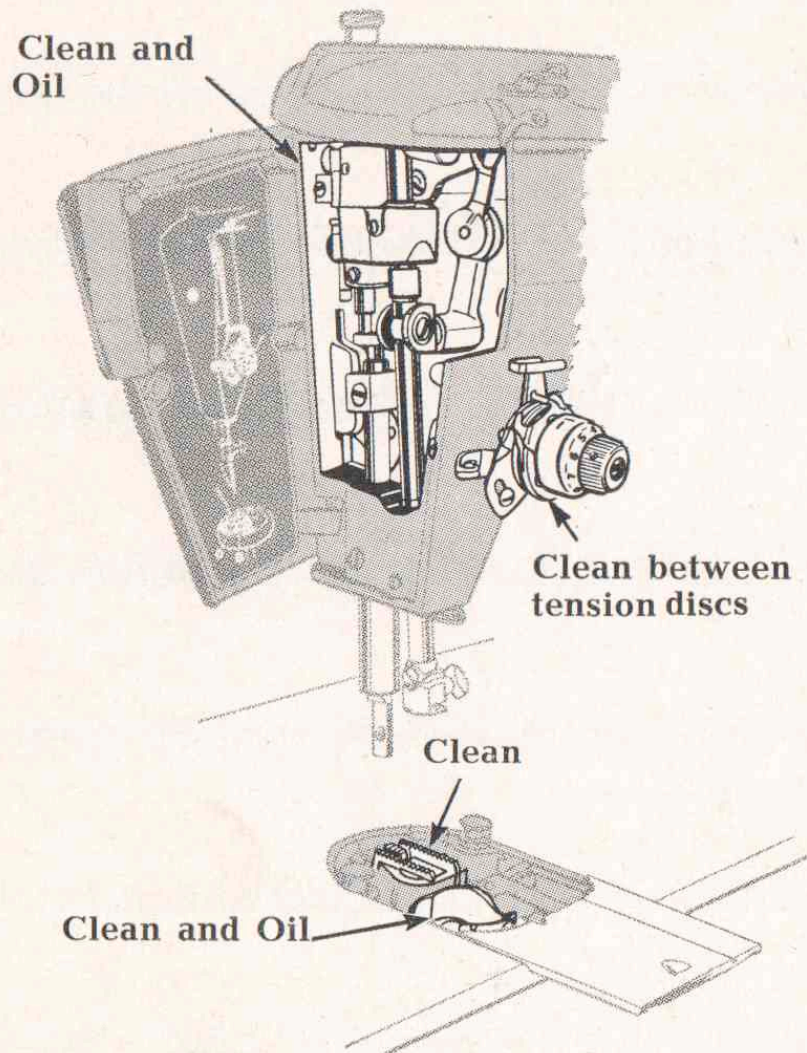

Your sewing machine was built to exacting standards of precision and workmanship. Its performance depends on the care and treatment it receives when in use and before storing it away.

When in regular use, the machine should be cleaned periodically to remove the lint and fluff which may have accumulated around the working parts. To clean the bobbin case area, see instructions for removing and replacing bobbin case on **pages 85 and 86**. Oil the machine after each cleaning as instructed on **pages 87, 88 and 89**.

If the machine is to be stored away for an indefinite period of time, a thorough brush-cleaning to remove all traces of lint and fluff, followed by swabbing of all exposed parts with a lint-free brush saturated with SINGER* Oil, is necessary to protect the machine against rust damage. The areas that should be cleaned and covered with a protective coat of oil are shown in the illustration at the left.

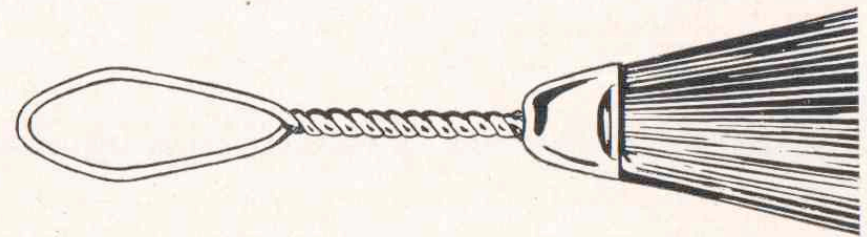

TO REMOVE AND REPLACE BOBBIN CASE

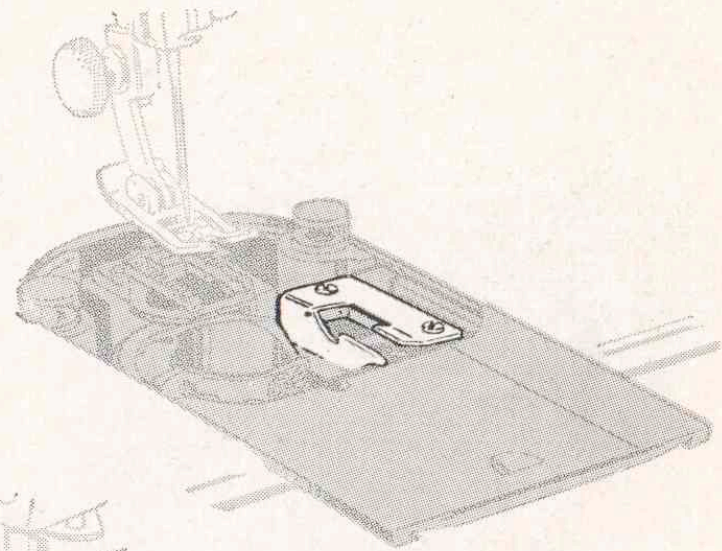
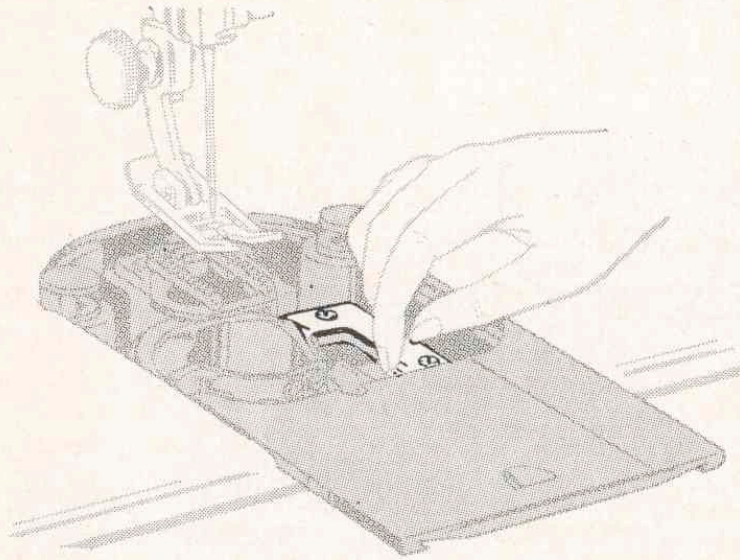

To clean hook raceway, remove bobbin case as follows:

1. Remove throat plate (see **page 21**) and open slide plate (see **page 14**).
2. Unlock bobbin case by lifting and pulling holder to right as shown.
3. Remove bobbin case from machine.
4. Remove all lint, fluff, loose thread ends or any other foreign matter which might clog the machine.

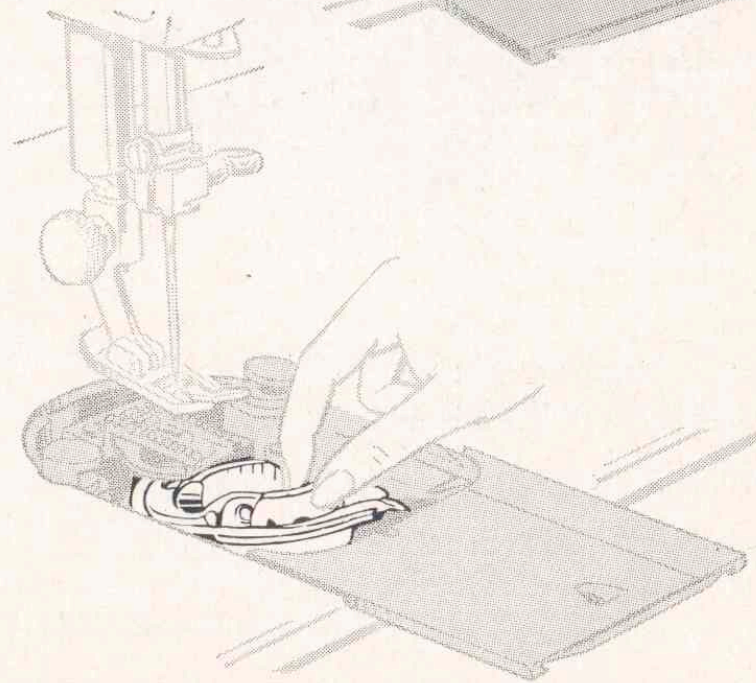

POSITIONING
STUD

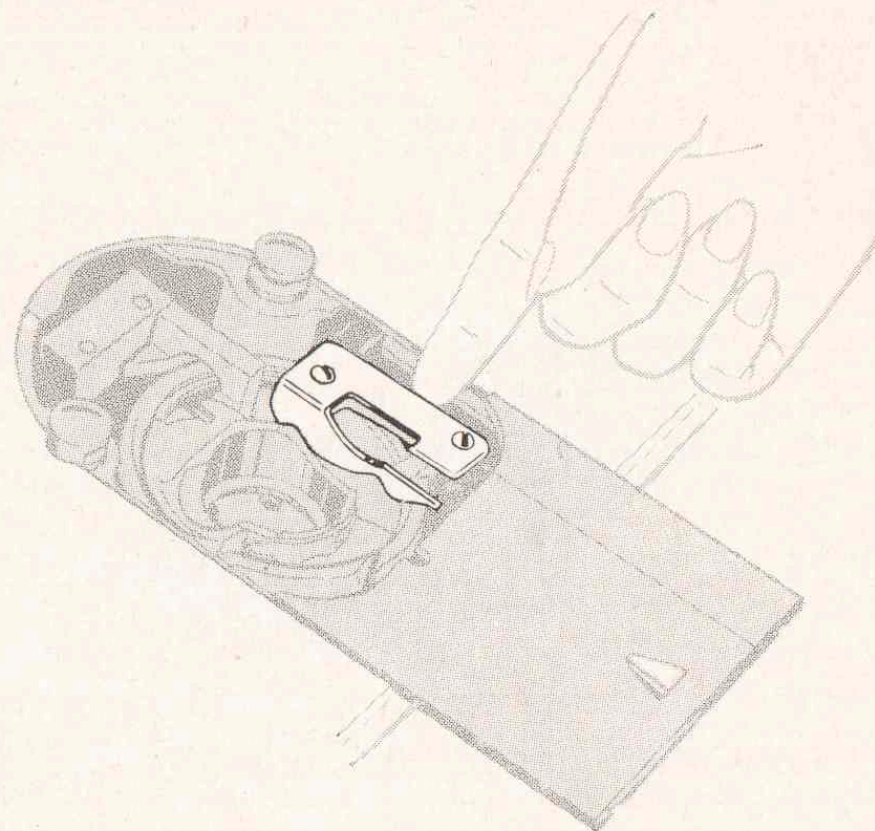
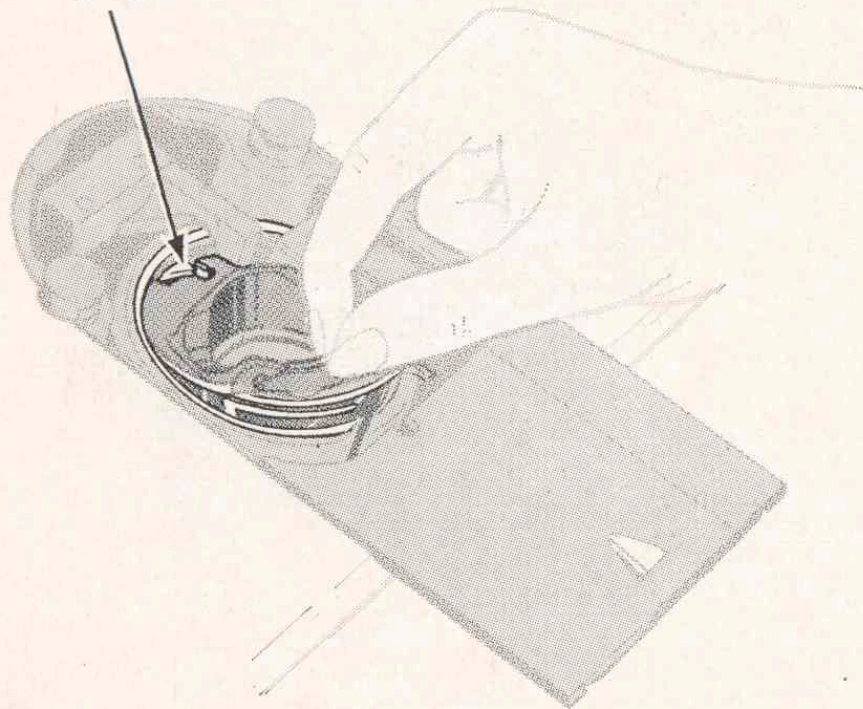

5. Replace bobbin case so that groove under tension spring fits on hook raceway and fork of case straddles positioning stud.
6. Push bobbin case holder to left as shown until it snaps down into lock position.
7. Close bed slide and replace throat plate.

TO LUBRICATE THE MACHINE

Use SINGER Oil and SINGER Lubricant!

Both are extra quality products especially prepared for sewing machines, and should always be used in the care of your 401.

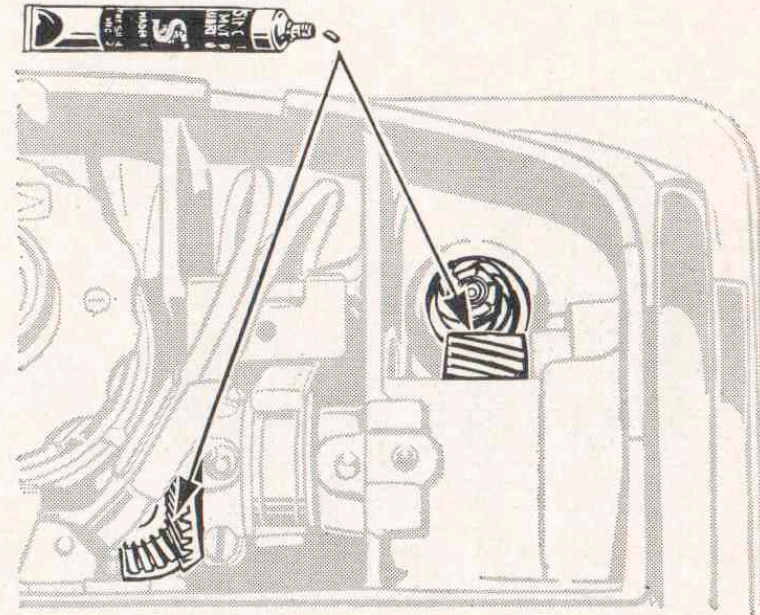
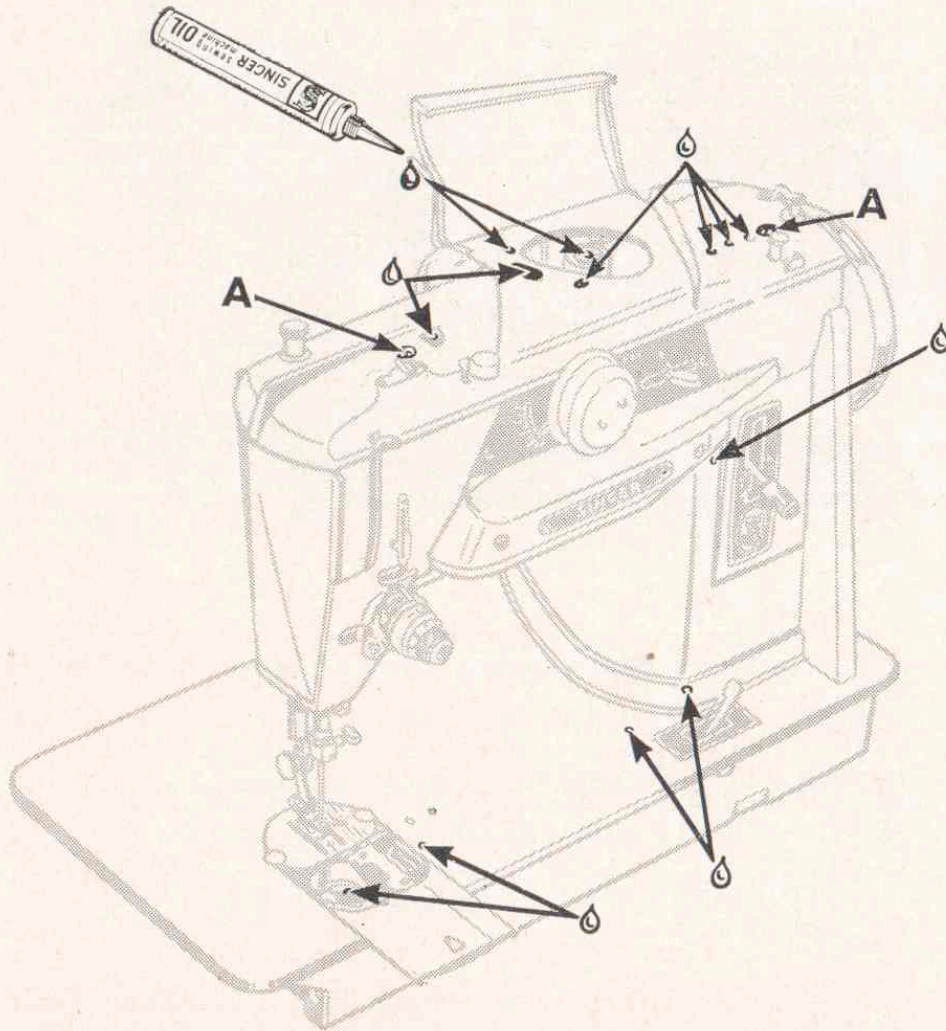

Clean the machine periodically as instructed on **page 84**.

Apply a drop of oil to each place indicated.

Remove screws **A** and lift off arm top cover.

Apply a small amount of lubricant to the gears as shown.

A tube of this lubricant can be purchased at your Singer Sewing Centre.

Never apply Oil to these gears.

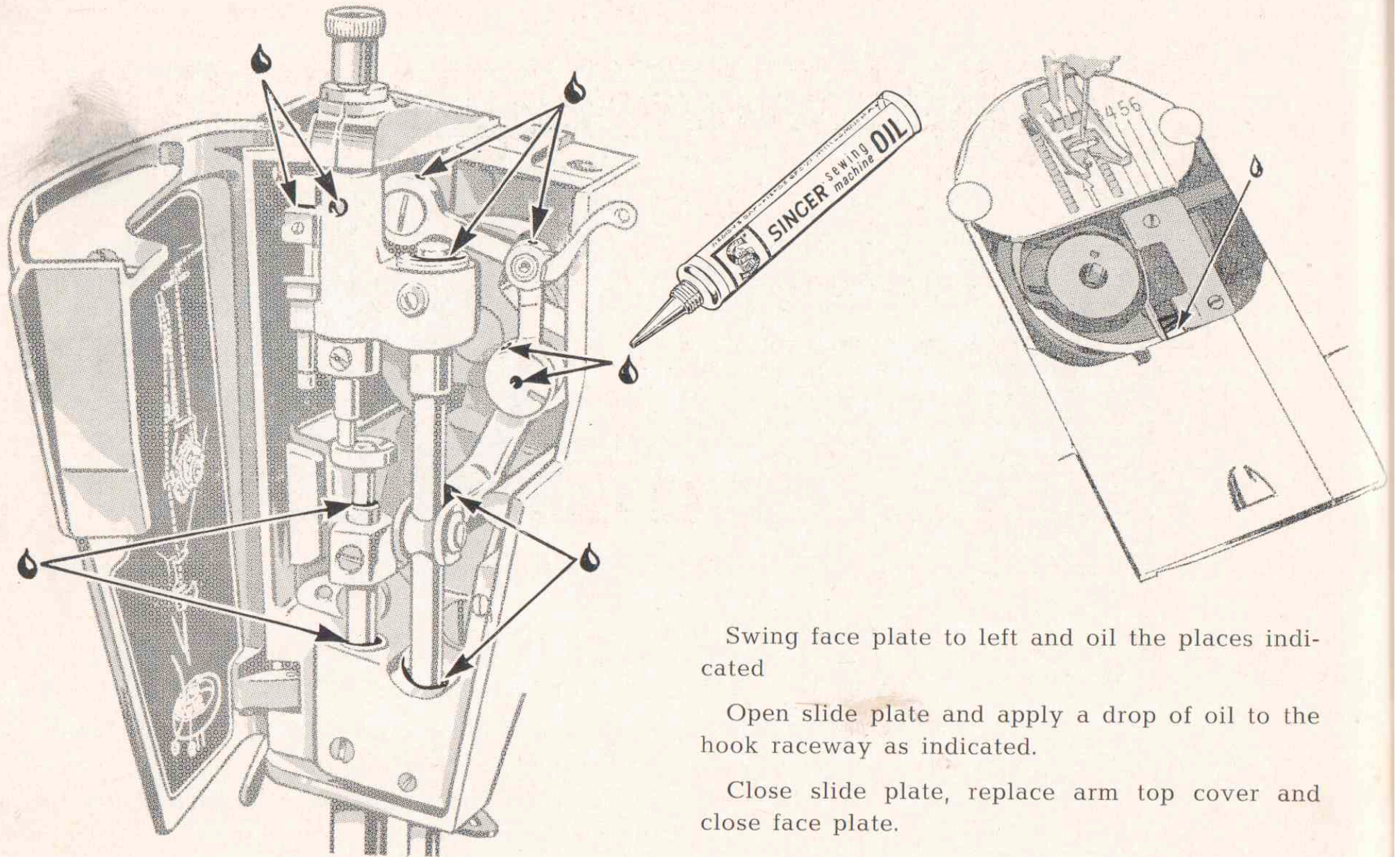

Swing face plate to left and oil the places indicated

Open slide plate and apply a drop of oil to the hook raceway as indicated.

Close slide plate, replace arm top cover and close face plate.

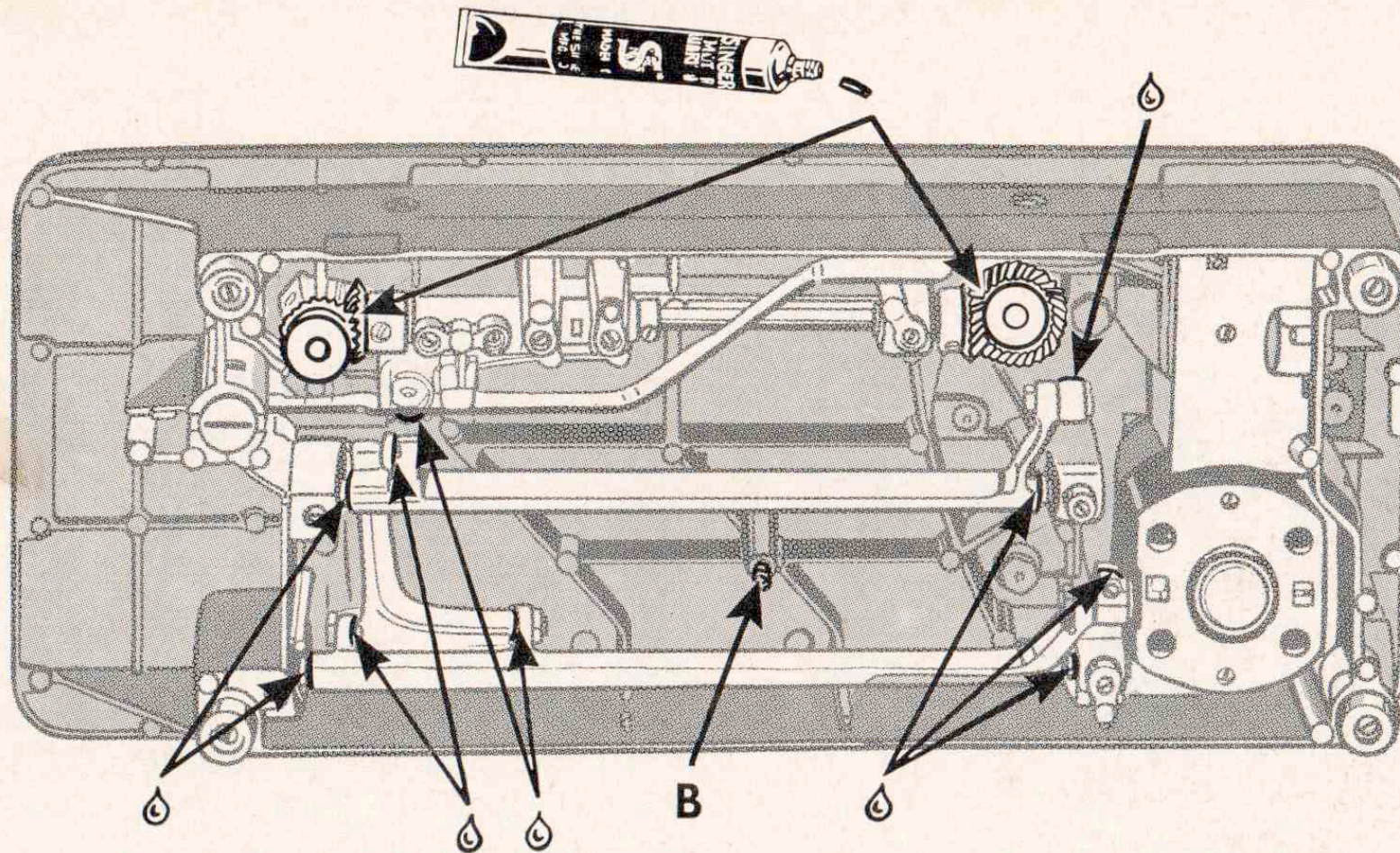

Tilt machine back and remove thumb nut from screw **B**, being careful not to lose felt washer, and remove cover from underside of machine.

Oil each of places indicated by arrows and occasionally apply a small quantity of lubricant to teeth of gears as shown.

Replace bottom cover.

THE MOTOR REQUIRES NO LUBRICATION.

ELECTRICAL INFORMATION

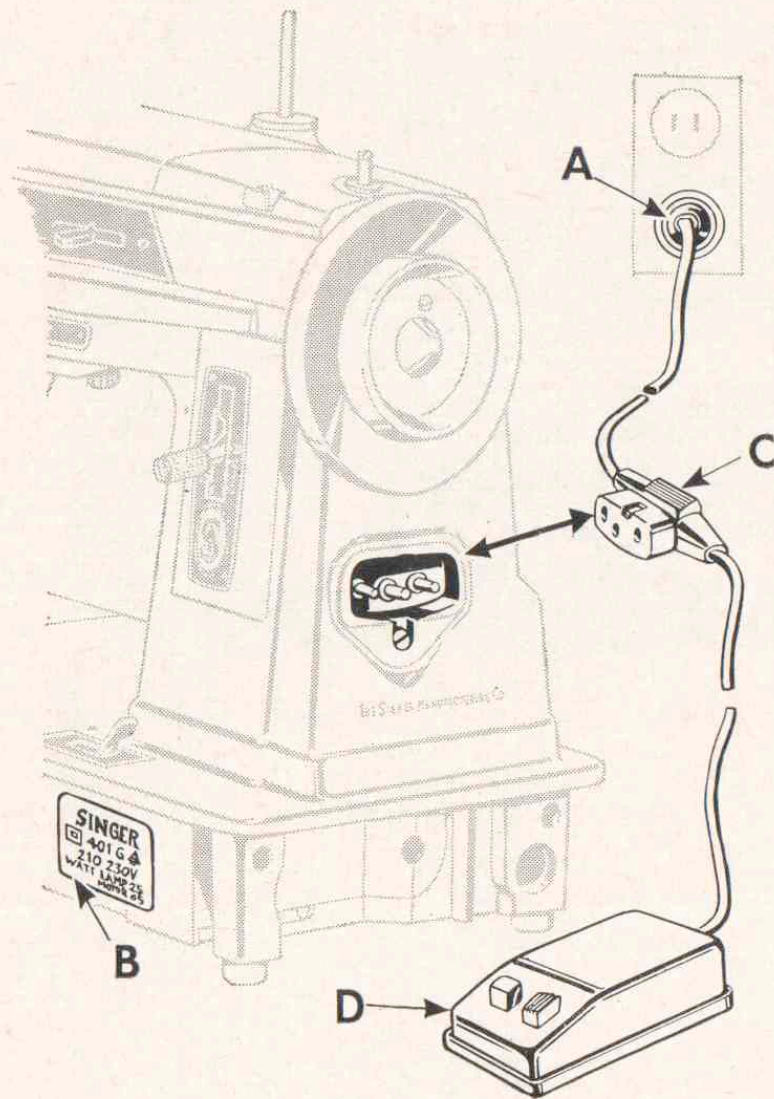

The **SINGER*** Electric Motor in the electric machine is furnished for operation on an alternating or direct current. Orders must state the catalogue number of the motor, or the voltage, and in the case of alternating current, the number of cycles.

Before Inserting Electric Plug A, be sure that voltage and cycles stamped on electrical nameplate **B** are within range marked on your electric meter installed by your power company.

Electrical Connections for Machine. Push 3-pin terminal plug **C** on 3-pin terminal block at right of machine and connect plug **A** at other end of cord to electric outlet.

Speed Controller. The speed of machine is regulated by amount of pressure on the pedal of the foot controller **D** or the knee lever.

SINGER* LIGHT

The light is turned „on“ or „off“ by the switch F.

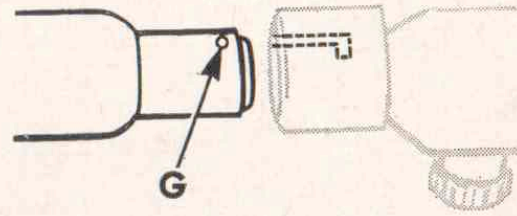
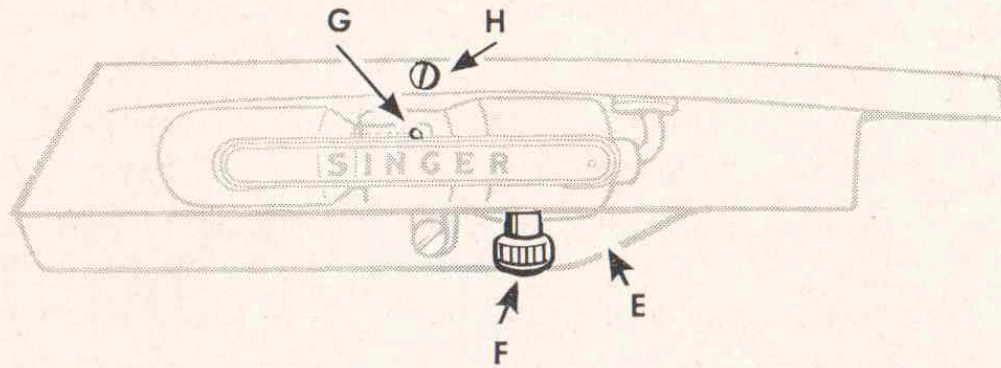

To Remove Bulb. Remove screw **H** and lamp cover **E**. Do not attempt to unscrew bulb. Press it into socket and at same time turn bulb over in direction shown to unlock bulb pin **G**, then withdraw bulb.

To Replace Bulb. Press new bulb into socket with bulb pin **G** entering slot of socket and turn it over in direction shown to lock bulb pin **G** in position. Replace lamp cover **E** and securely fasten it in position with screw **H**.

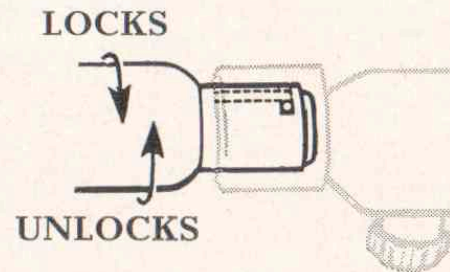

TREADLE INFORMATION

To Replace Belt

Remove arm top cover as instructed on **page 87**.

Remove belt guard by removing screw at top of guard.

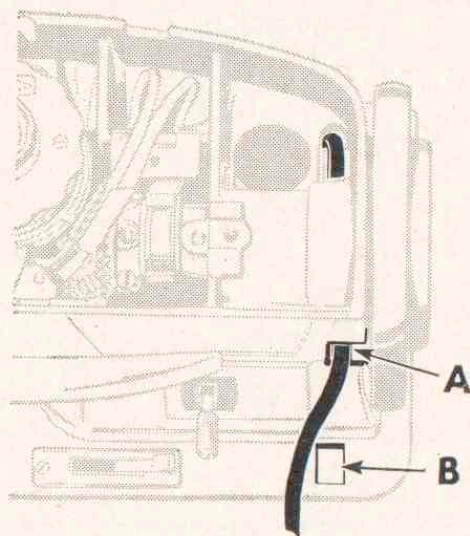

Insert end of belt into cutout **A** so that it enters groove in hand wheel.

Lead belt around hand wheel and down through hole provided in machine casting, as shown.

Insert opposite end of belt into cutout **B** in bed of machine.

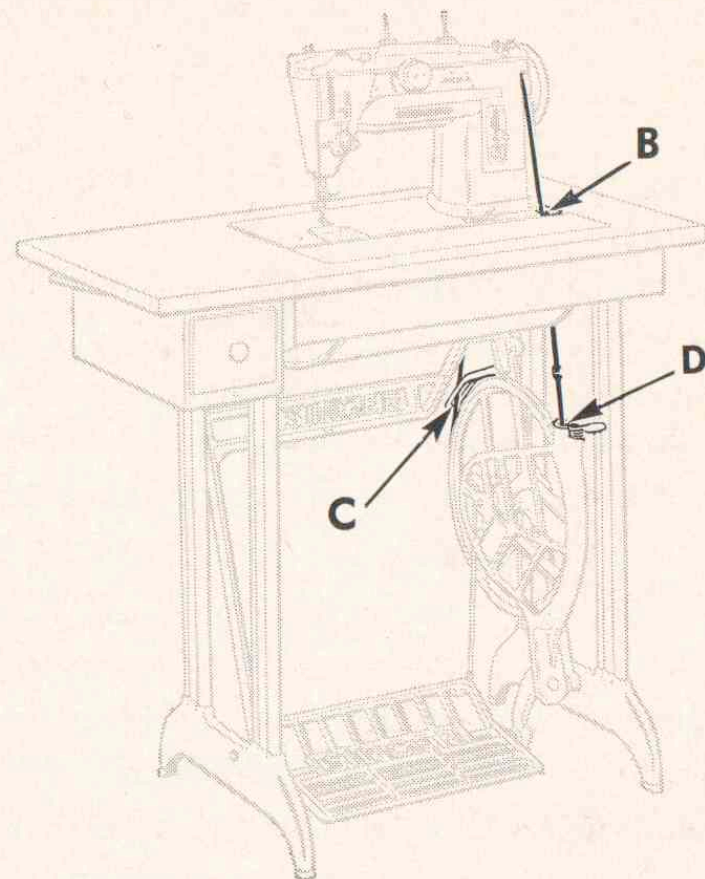

Lead belt through guide **C**, around band wheel and into eye of belt shifter **D**.

Join both ends of belt. (Tension on belt should be only heavy enough to keep belt from slipping.)

Replace arm top cover and belt guard.

Operate treadle as instructed on **pages 8 and 9**.

INDEX

	Page		Page
Applique	48—49	Cording	
Attachments		Seams	70
Foot Hemmer	71—73	Welting	69
Multi-Slotted Binder	74—75	Couching	52
Ruffler	76—79	Darning	80
Binding	74—75	Darts	58—59
Blanket Binding, Replacing	59	Interfacing	59
Blind Stitching		Single Thread	58
Hems	64	Decorative Hems	73
Zipper Insertion	68	Decorative Stitch Patterns	82—83
Bobbin		Designs and Motifs	50
Case Threading	15	Elastic	
Preparation for Stitching	24	Applied Band	60
Removing	14	Girdle Repair	60
Thread Tension	30	Electrical Information	90—91
Winding	11—13	Motor	90
Buttonholes	44—47	SINGER Light	91
Corded	47	Embroidery: Free Motion	80—81
Button Sewing	53—54	Fabrics, Guiding and Supporting	27
Cleaning	84—86	Features	3
Combination Patterns and Variations	39	Principal Parts	16
Illustrations	82—83	Filler Cord, Threading	47
Corded Applique	49	Finishes, Seam	57
Corded Buttonholes	47	Foot Hemmer	71—73
		Decorative Hems	73
		Hemming with Lace	72
			93

	Page		Page
Free Motion Work	80—81	Needle and Thread Selection	5
Darning	80	Needle Thread Tension	
Embroidery	81	Satin Stitching	33
Monograms	81	Straight Stitching	29
Satin Stitch Scallops	81	Needle Threading	
Gathering	77	Single	10
General Purpose Foot, Applications	55—61	Two	41
Guiding and Supporting Fabric	27	Oiling	87—89
Hemming with Lace	72	Overcasting	57
Hems		Pleating	79
Blindstitched	64	Prepare to Sew	24
Decorative	73	Pressure Adjustments	28
Interfacing Darts	59	Primary Patterns	34—38
Knit Fabric Seams	56	Needle Position	38
Lace		Red Lever	37
Applique	49	Special Discs	35—36
Edging and Insertion	52 and 72	Principal Parts of Machine	16
Length of Stitch, Regulating	17	Red Lever	
Light Bulb, Replacement	91	Combinations and Variations	39
Lubricating	87—89	Control of Width	37
Mending	60	Operation	18
Monograms and Motifs	50	Removal and Replacement of Bobbin	14—15
Free Motion	80—81	Removal and Replacement of Special Discs	36
Motor	90	Rent or Tear Mending	60
Multi-Slotted Binder	74—75	Reverse Stitching	
Needle Insertion	6 and 40	Application	25—26
Needle Positions	23 and 38	Regulation	17

	Page
Ruffler	76—79
Attaching Ruffle	78
Gathering	77
Pleating	79
Satin Stitching	
Stitch Length Adjustment	32
Tension Adjustment	33
Scalloping	61
Free Motion	80—81
Primary Patterns	34
Special Disc	35
Seam Finishes	57
Seam Guide	62—64
Blindstitched Hems	64
Seams	62—63
Top Stitching	63
Seams	
Corded	70
Flat Felled	56
Knit Fabric	56
Lingerie	55
Sheer Fabrics	51
Straight	25—26
Supporting and Guiding	27
Selector: Operation	19
Sheer Fabric Seams	51
SINGER Service	4
Single Thread Darts	58

	Page
Special Discs	
Primary Patterns	35
Removal and Replacement	36
Special Purpose Foot, Applications	44—52
Stitch Length	
Regulator	17
Satin Stitch Adjustment	32
Stitch Patterns	
Combinations and Variations	39
Illustrations	82—83
Special Discs	35
Stitch Selector, Operation	19
Straight Stitching	
Equipment and Settings	22—23
Seams	25—26
Secondary Positions	23
Two Needles	42
Tear or Rent Mending	60
Tension Adjustments	
Bobbin	30
Needle Thread	29
Satin Stitching	33
Threading	
Bobbin Case	15
Filler Cord	47
Single Needle	10
Two Needles	41

	Page		Page
Throat Plate		Welting	69
Changing	21	Winding a Bobbin	11—13
Positions	20	Zigzag Stitching	
Straight Stitch	22	Combinations and Variations	39
Zigzag Stitch	31	Equipment	31
Top Stitching	63	Needle Positions	38
Treadle Information		Primary Patterns	34
To Replace Belt	92	Red Lever: Control of Widths	37
Two Needles	40—43	Special Discs	35—36
Insertion	40	Stitch Length Adjustment	32
Primary Patterns	43	Tension Adjustment	33
Straight Stitching	42	Two Needles	43
Threading	41	Zipper Foot	65—70
Variation and Combination Patterns	39	Welting and Corded Seams	69—70
Illustrations	82—83	Zipper Insertion	66—68